

Canon

PowerShot S30

PowerShot S40

DIGITAL CAMERA

Camera User Guide



Flowchart and Reference Guides

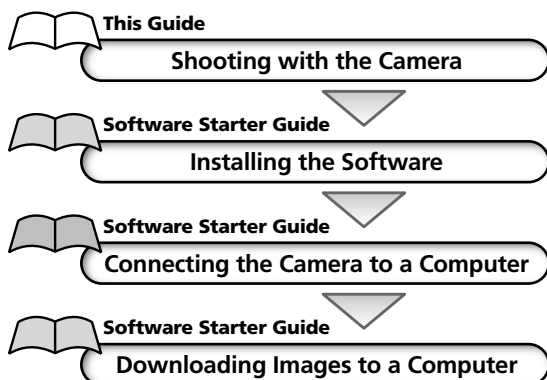

- This guide covers both the PowerShot S30 and PowerShot S40 digital cameras.
- Please start by reading the Precaution on the reverse side of this cover.
- For information about how to use the Card Photo Printer CP-10 and Bubble Jet Printer with the direct print function, please refer to the *User Guide* of each printer.

DPOF[™]

DIRECT PRINT

BUBBLE JET DIRECT

ENGLISH

Precaution

Camera Body Temperature

If your camera is used for prolonged periods, the camera body may become warm. Please be aware of this and take care when operating the camera for an extended period.

About the LCD Monitor

The LCD monitor is produced with extremely high-precision manufacturing techniques. More than 99.99% of the pixels operate to specification. Less than 0.01% of the pixels may occasionally misfire or appear as red or black dots. This has no effect on the recorded image and does not constitute a malfunction.

Please read through the "Read This First" section (p. 4) before using your camera.

Video Format

Please set the camera's video signal format to the one used in your region before using it with a TV monitor (p. 138).

Language Setting

Please see page 25 to change the language setting.

Charging the Date/Time Battery

- The camera has a built-in rechargeable lithium battery that maintains the date, time and other camera settings. This battery recharges when the main battery pack is inserted into the camera. When you first purchase the camera, place a charged battery pack in it or use the AC adapter kit (sold separately) for at least 4 hours to charge the date/time battery. It will charge even when the camera power is set to Off.
- If the Set Date/Time menu appears when the camera power is turned on, it means that the date/time battery charge is depleted. Recharge it as described above.











Disclaimer











- While every effort has been made to ensure that the information contained in this guide is accurate and complete, no liability can be accepted for any errors or omissions.
- Canon Inc. reserves the right to change the specifications of the hardware and software described herein at any time without prior notice.
- No part of this guide may be reproduced, transmitted, transcribed, stored in a retrieval system, or translated into any language in any form, by any means, without the prior written permission of Canon Inc.
- Canon Inc. makes no warranties for damages resulting from corrupted or lost data due to a mistaken operation or malfunction of the camera, the software, the CompactFlash™ cards (CF cards), personal computers, peripheral devices, or use of non-Canon CF cards.

Trademark Acknowledgements

- Canon, PowerShot and Bubble Jet are trademarks of Canon, Inc.
- CompactFlash is a trademark of SanDisk Corporation.
- Other names and products not mentioned above may be registered trademarks or trademarks of their respective companies.

Table of Contents

Read this First	4
Quick Start	8
Components Guide	10
Front View	10
Back / Bottom View	11
Controls	12
Shooting Mode Dial	13
Operating the Multicontroller	14
Preparing the Camera	15
Charging the Battery Pack	15
Installing the Battery Pack	17
Using a Household Power Source	19
Installing a CF Card	21
Setting the Date / Time	24
Setting the Language	25
Attaching the Strap	26
Using the Soft Case (Optional)	26
Basic Functions	27
Turning the Power On / Off	27
Switching between Shooting and Replaying	29
Switching the LCD Monitor Display Mode	30
Pressing the Shutter Button	34
Using the Optical Viewfinder to Shoot	36
Adjusting the Zoom (Focal Length)	37
Selecting Menus and Settings	38
Customizing the Camera (My Camera Settings)	41
Changing My Camera Settings	41
Customizing My Camera Settings	43
Shooting - Letting the Camera Select Settings	44
 Auto Mode	44
Checking an Image Right after Shooting	46
 Using the Flash	47
 Portrait Mode	49
 Landscape Mode	49
 Night Scene Mode	50
 Fast Shutter	50
 Slow Shutter	51
 Changing the Color Effect	52
 Stitch Assist Mode	53
 Movie Mode	56
 Macro Mode	57

 Self-Timer	58
 Continuous Mode	59
Digital Zoom	60
Shooting - Selecting Particular Effects	61
Changing the Resolution and Compression	61
Changing the File Format	64
P Program AE	65
Tv Setting the Shutter Speed	66
Av Setting the Aperture	68
M Manually Setting the Shutter Speed and Aperture	70
 Selecting an AF frame	71
 Adjusting the Exposure Compensation	73
WB Setting the White Balance	74
 Auto Exposure Bracketing (AEB Mode)	77
 Adjusting the Flash Output (Flash Exposure Compensation)	78
 Locking the Exposure Setting (AE Lock)	79
 Locking the Flash Exposure Setting (FE Lock)	81
 Switching Between Light Metering Modes	82
Shooting Problem Subjects for the Autofocus	84
Manually Setting Image Characteristics	87
Resetting the File Number	89
Functions Available in Each Shooting Mode	90
Replaying	92
Viewing Images Singly (Single Image Replay)	92
 Magnifying Images	93
 Viewing Nine Images at a Time (Index Replay)	94
JUMP Jumping Between Images	95
Viewing Movies	96
Rotating Images in the Display	97
Attaching Sound Annotations to Images	98
Automated Playback (Slide Show)	99
Protecting Images	103
Erasing	104
Erasing Images Singly	104
Erasing All Images	105
Formatting a CF Card	106
Print Settings (DPOF Print Settings)	107
Selecting Images for Printing	107
Setting the Print Style	109
Resetting the Print Settings	111

Printing with Card Photo Printer CP-10 (Optional)	112
Connecting Card Photo Printer CP-10 to the Camera	112
Printing	114
Printing with DPOF Print Settings on Card Photo Printer CP-10	119
Printing with Bubble Jet Printer (Optional)	121
Connecting Bubble Jet Printer to the Camera	121
Printing	123
Printing with DPOF Print Settings on Bubble Jet Printer	128
Image Transfer Settings (DPOF Transfer Order)	130
Selecting Images for Transferring	130
Resetting the Transfer Settings	132
List of Menu Options	133
Rec. Menu	133
Play Menu	136
Set up Menu	137
My Camera Menu	139
Resetting all of the Settings to Default	141
Shooting / Replaying with a TV Monitor	142
Appendices	143
Camera Care and Maintenance	143
Troubleshooting	144
List of Messages	147
Specifications	151
Index	155
Canon Customer Support	158

Icon Conventions in the Text

.....



This mark denotes topics about issues that may affect the camera's operation.

.....



This mark denotes additional topics that complement the basic operating procedures.

.....



This mark denotes tips about the camera and photography.

Read this First

Please Read

Test Shots

Before you try to photograph important subjects, we highly recommend that you shoot several trial images to confirm that the camera is operating and being operated correctly. Please note that Canon Inc., its subsidiaries and affiliates, and its distributors are not liable for any consequential damages arising from any malfunction of a camera or accessory, including CompactFlash™ cards, that results in the failure of an image to be recorded or to be recorded in a format that is machine sensible.

Warning Against Copyright Infringement

Please note that Canon digital cameras are intended for personal use and should never be used in a manner that infringes upon or contravenes international or domestic copyright laws and regulations. Please be advised that in certain cases the copying of images from performances, exhibitions, or commercial properties by means of a camera or other device may contravene copyright or other legal rights even if the image was shot for personal use.

Warranty Limitations

This camera's warranty is only effective in the country of sale. If a problem arises while the camera is in use abroad, please convey it back to the country of sale before proceeding with a warranty claim to a Canon Customer Support Help Desk.

Safety Precautions

- Before using the camera, please ensure that you read and understand the safety precautions described below. Always ensure that the camera is operated correctly.
- The safety precautions noted on the following pages are intended to instruct you in the safe and correct operation of the camera and its accessories to prevent injuries or damage to yourself, other persons and equipment.
- In the next few pages, the term "equipment" refers primarily to the camera, its power supply accessories and an optional compact power adapter.

Warnings

- Do not aim the camera directly into the sun or at other intense light sources which could damage your eyesight.

- Do not trigger the flash in close proximity to human or animal eyes. Exposure to the intense light produced by the flash may damage eyesight. In particular, remain at least one meter (39 inches) away from infants when using the flash.

- Store this equipment out of the reach of children and infants. Accidental damage to the camera or batteries by a child could result in serious injury. In addition, placement of the strap around the child's neck could result in asphyxiation.

- Do not attempt to disassemble or alter any part of the equipment that is not expressly described in this guide. Disassembly or alteration may result in high-voltage electrical shock. Internal inspections, alterations and repairs should be conducted by qualified service personnel authorized by your camera distributor or a Canon Customer Support Help Desk.

- To avoid the risk of high-voltage electrical shock, do not touch the flash portion of the camera if it has been damaged. Similarly, never touch internal portions of the equipment that become exposed as a result of damage. There is a risk of high-voltage electrical shock. Please take the first opportunity to consult your camera distributor or a Canon Customer Support Help Desk.

- Stop operating the equipment immediately if it emits smoke or noxious fumes. Failure to do so may result in fire or electrical shock. Immediately turn the camera's power off, remove the camera battery and unplug the power cord from the electrical outlet. Confirm that smoke or fume emissions have ceased. Please consult your camera distributor or the closest Canon Customer Support Help Desk.

- Stop operating the equipment if it is dropped or the casing is damaged. Failure to do so may result in fire or electrical shock. Immediately turn the camera's power off, remove the camera battery and unplug the power cord from the electrical outlet. Please consult your camera distributor or the closest Canon Customer Support Help Desk.

- Do not allow the equipment to come into contact with, or become immersed in, water or other liquids. Do not allow liquids to enter the interior. The camera has not been waterproofed. If the exterior comes into contact with liquids or salt air, wipe it dry with a soft, absorbent cloth. In the event that water or other foreign substances enter the interior, immediately turn the camera's power off and remove the camera battery or unplug the power cord from the electrical outlet. Continued use of the equipment may result in fire or electrical shock. Please consult your camera distributor or the closest Canon Customer Support Help Desk.

- Do not use substances containing alcohol, benzene, thinners or other flammable substances to clean or maintain the equipment. The use of these substances may lead to fire.

-
- Remove the power cord on a regular periodic basis and wipe away the dust and dirt that collects on the plug, the exterior of the electrical outlet and the surround area. In dusty, humid or greasy environments, the dust that collects around the plug over long periods of time may become saturated with humidity and short-circuit, leading to fire.
-
- Do not cut, damage, alter or place heavy items on the power adapter cord. Any of these actions may cause an electrical short circuit, which may lead to fire or electrical shock.
-
- Do not handle the power cord if your hands are wet. Handling it with wet hands may lead to electrical shock. When unplugging the cord, ensure that you hold the solid portion of the plug. Pulling on the flexible portion of the cord may damage or expose the wire and insulation, creating the potential for fires or electrical shocks.
-
- Use of power sources not expressly recommended for this equipment may lead to overheating, distortion of the equipment, fire, electrical shock or other hazards. Use only the recommended power accessories.
-
- Do not place the batteries near a heat source or expose them to direct flame or heat. Neither should you immerse them in water. Such exposure may damage the batteries and lead to the leakage of corrosive liquids, fire, electrical shock, explosion or serious injury.
-
- Do not attempt to disassemble, alter or apply heat to the batteries. There is serious risk of injury due to an explosion. Immediately flush with water any area of the body, including the eyes and mouth, or clothing, that comes into contact with the inner contents of a battery. If the eyes or mouth contact these substances, immediately flush with water and seek medical assistance.
-
- Avoid dropping or subjecting the batteries to severe impacts that could damage the casings. It could lead to leakage and injury.
-
- Do not short-circuit the battery terminals with metallic objects, such as key holders. It could lead to overheating, burns and other injuries. Use the supplied terminal cover to transport or store the battery pack.
-
- Before you discard a battery, cover the terminals with tape or other insulators to prevent direct contact with other objects. Contact with the metallic components of other materials in waste containers may lead to fire or explosions. Discard the batteries in specialized waste facilities if available in your area.
-
- Use NB-2L battery pack only. Use of other batteries may cause explosions or leaks, resulting in fire, injury and damage to the surroundings.
-
- Use the supplied battery charger to charge the NB-2L battery pack. Use of other battery chargers may cause the unit to overheat and distort, resulting in fire or electrical shock.
-
- Disconnect the battery charger or the compact power adapter from both the camera and electrical outlet after recharging and when the camera is not in use to avoid fires and other hazards.
-
- The battery charger and the camera terminal of the optional compact power adapter are designed for exclusive use with this camera. Do not use it with other products . There is a risk of fire and other hazards.
-

6 Read This First

- Always keep the terminals of the battery charger clean. Do not place metal objects on top of the terminals. There is a risk of fire and other hazards.

Cautions

- Avoid using, placing or storing the equipment in places subject to strong sunlight or high temperatures, such as the dashboard or trunk (boot) of a car. Exposure to intense sunlight and heat may cause the batteries to leak, overheat or explode, resulting in fire, burns or other injuries. High temperatures may also cause deformation of the casing. Ensure that there is good ventilation when using the compact power adapter to charge the battery pack or power the camera.
- Do not store the equipment in humid or dusty areas. Storage in such areas could lead to fire, electrical shock or other damage.
- Be careful not to bang the camera or subject it to strong impacts or shocks that could lead to injury or damage the equipment when wearing or holding it by the strap.
- Be careful not to cover the flash with your fingers when shooting. In addition, do not touch the surface of the flash after taking several pictures in rapid succession. Either action could result in burns.
- If your camera is used for prolonged periods, the camera body may become warm. Please take care when operating the camera for an extended period as your hands may experience a burning sensation.

Preventing Malfunctions

■ Avoid Strong Magnetic Fields

Never place the camera in close proximity to electric motors or other equipment generating strong electromagnetic fields. Exposure to strong magnetic fields may cause malfunctions or corrupt image data.

■ Avoid Condensation Related Problems

Moving the equipment rapidly between hot and cold temperatures may cause condensation (water droplets) to form on its external and internal surfaces. You can avoid this by placing the equipment in an airtight, resealable plastic bag and letting it adjust to temperature changes slowly before removing it from the bag.

■ If Condensation Forms Inside the Camera

Stop using the camera immediately if you detect condensation. Continued use may damage the equipment. Remove the CF card, and battery or a household power source, from the camera and wait until the moisture evaporates completely before resuming use.

Quick Start

1

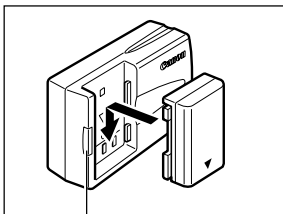

Charging indicator

Charge the Battery (p. 15).

Charge the battery using the supplied battery charger. The charging is complete when the charging indicator turns from orange to green.

- Please note that the battery charger shape varies between regions.

2

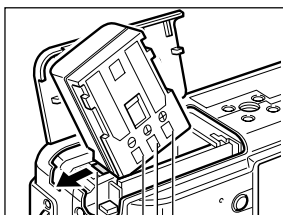

Battery lock

Terminals

Install the Battery (p. 17).

Open the CF card slot/battery cover. Hold back the battery lock in the direction of the arrow using the corner of the battery pack, then insert the battery pack into the compartment until it is locked.

3

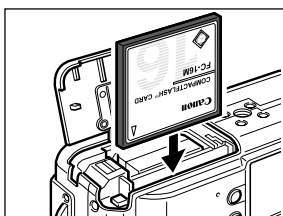

Install the CF card (p. 21).

4

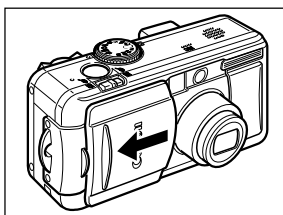

Open the lens cover (p. 27).

The camera powers up into Shooting mode.

- If the [Set Date/Time] menu appears on the LCD monitor, set the date and time (p. 24).

5

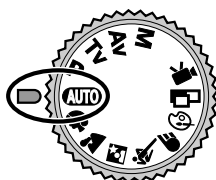

Turn the Shooting Mode dial to **AUTO** (p. 44).

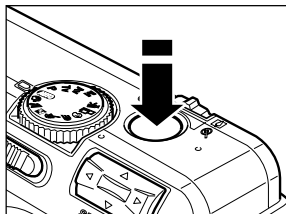
6**Focus (p. 34).**

Aim the camera and lightly press the shutter button halfway. Two beeps will sound when the autofocus is set.

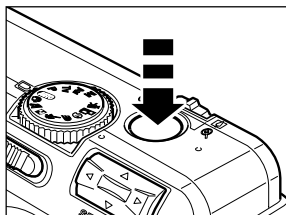
7**Shoot (p. 34).**

Press the shutter button all the way. You will hear the sound of the shutter close when the shot is complete.

8**View the recorded image (p. 46).**

The recorded image appears in the LCD monitor for approximately 2 seconds. Keep your finger on the shutter button, or press **SET** on the multicontroller while the image is displayed to continue to display the image after the shutter button is released.

**To Immediately Delete the Displayed Image**

1. Press the  button while the image is displayed.
2. Confirm that [Erase] is selected and press **SET** on the multicontroller.



Front View

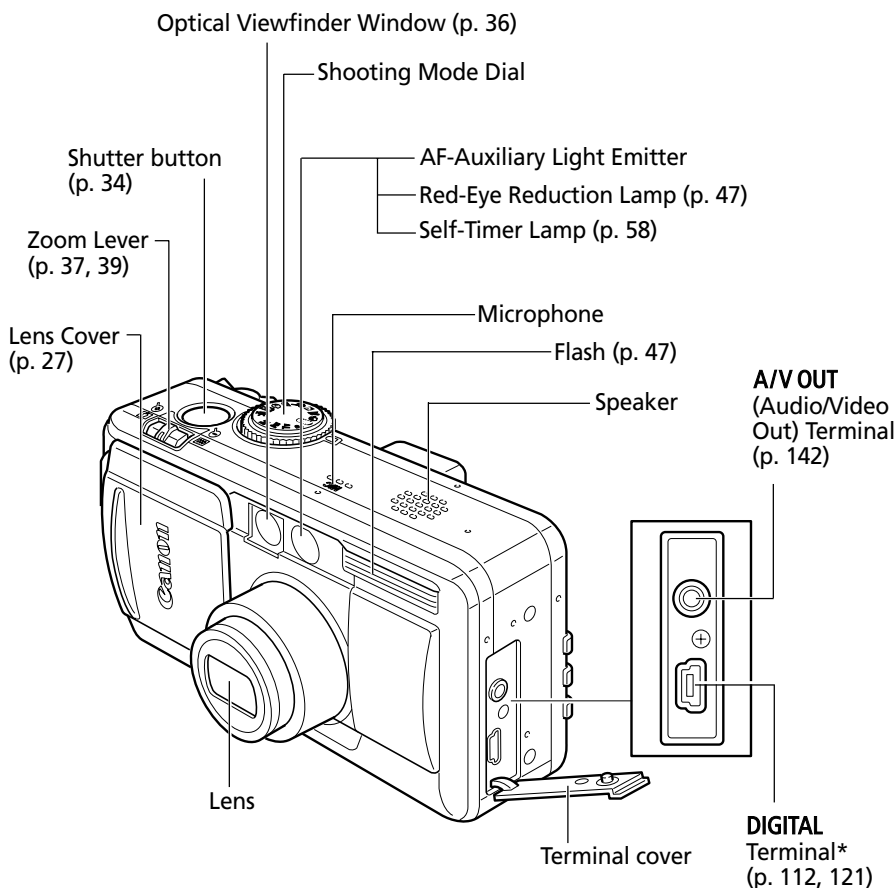

* To connect the camera to a computer or printer, use one of the following cables.

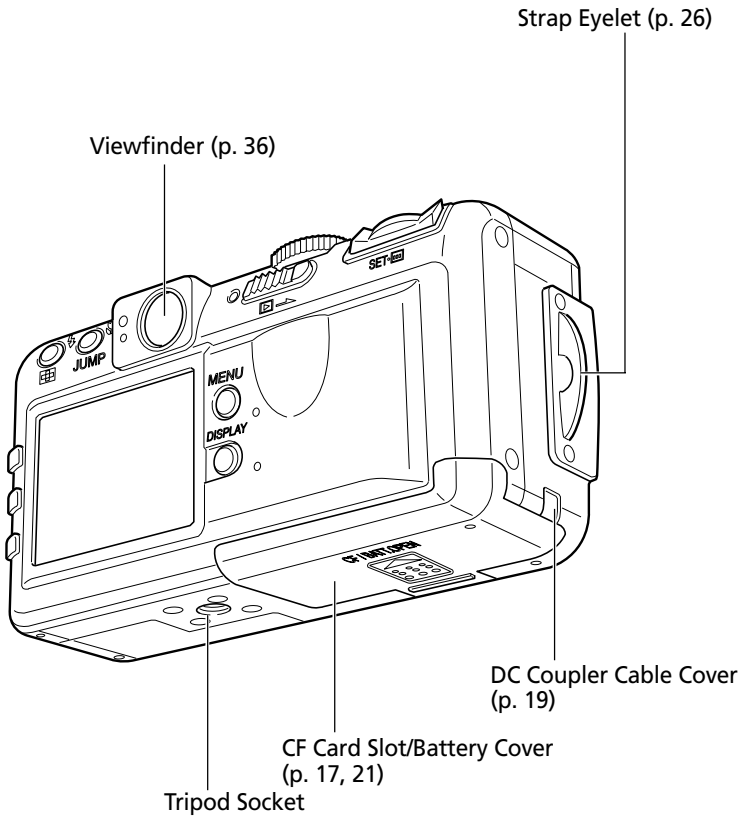

- Computer: USB Interface Cable IFC-300PCU (supplied with this camera)
- Card Photo Printer CP-10 (optional): Direct Interface Cable DIF-100 (supplied with the CP-10)
- Bubble Jet Printer with the direct print function (optional): Bubble Jet Printer-digital camera connection cable (supplied with the Bubble Jet Printer)

Back / Bottom View





- The LCD monitor is covered with a thin plastic film for protection against scratches during shipment. Remove it before using the camera.

Controls

 (Exposure) / **WB** (White Balance) /
 (AEB) /  (Flash Exposure
 Compensation) Button (p. 73, 74, 77, 78)

Power/Mode Indicator (p. 27)



Power/Replay Lever (p. 27, 29)

 (Flash) /  (Index)
 Button (p. 47, 94)

 (Macro) /
JUMP (Jump)
 Button (p. 57, 95)

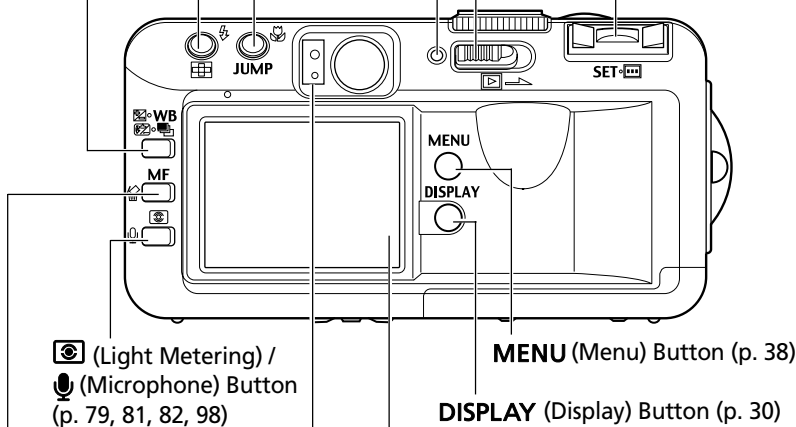
Multicontroller (p. 14, 71)



 (Light Metering) /
 (Microphone) Button
 (p. 79, 81, 82, 98)

MENU (Menu) Button (p. 38)

DISPLAY (Display) Button (p. 30)

MF (Manual Focus) /
 (Single image erase)
 Button (p. 85, 86, 104)

LCD Monitor (p. 30)

● Upper Indicator

The indicators shine or flash when the shutter button is pressed or the following operations are underway.

- Green: Ready to record / Ready to communicate (during a computer connection)
- Flashing Green: Powering up / Recording to CF card / Reading CF card / Erasing from CF card / Transmitting data (during a computer connection)
- Orange: Ready to record (flash on)
- Flashing Orange: Ready to record (camera shake warning)

● Lower Indicator

- Yellow: Macro mode / Manual focus mode
- Flashing Yellow: Focusing difficulty (although you can press the shutter button, try using focus lock or adjusting the focus manually, p. 86)

Shooting Mode Dial

Use the shooting mode dial to switch between the shooting modes.

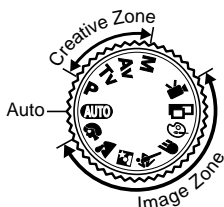

- **AUTO** : Auto (p. 44)

The camera automatically selects settings.

- **Image Zone**

The camera automatically selects settings according to the image composition type.

- Portrait (p. 49)
- Landscape (p. 49)
- Night Scene (p. 50)
- Fast Shutter Speed (p. 50)
- Slow Shutter Speed (p. 51)
- Color Effects (p. 52)
- Stitch Assist (p. 53)
- Movie (p. 56)

- **Creative Zone**

The user selects exposure, aperture or other settings to achieve special effects.

- P** : Program AE (p. 65)
- Tv** : Shutter Speed-Priority AE (p. 66)
- Av** : Aperture-Priority AE (p. 68)
- M** : Manual Exposure (p. 70)

Operating the Multicontroller

The multicontroller is used to select choices, images and menus on the LCD monitor and confirm the selection.

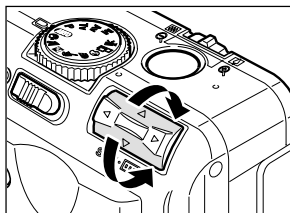

Moving the cursor on the LCD monitor up and down.

Use ▲ or ▼ to select a menu item on the LCD monitor.

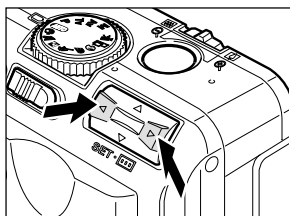

Moving the cursor on the LCD monitor left and right.

Use ◀ or ▶ to select a menu item on the LCD monitor.

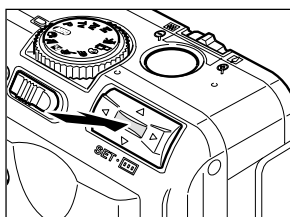

Confirming a menu selection or selecting an AF frame.

Press SET or .

Preparing the Camera

Charging the Battery Pack

Recharge Battery Pack NB-2L (supplied) with Battery Charger CB-2LT or CB-2LTE before you use the camera for the first time and subsequently when the “Charge the battery pack” message is displayed.

1

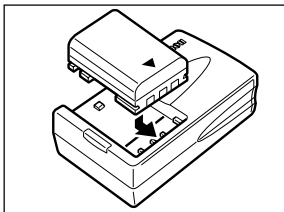

Align the edge of the battery pack with the line on the battery charger, then slide the battery in the direction of the arrow.

2

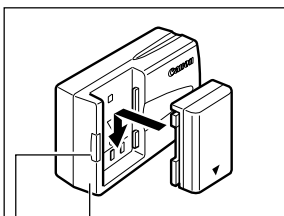

CB-2LT
Charging Indicator

Battery charger model names and types vary by region.

(For CB-2LT)

Plug the battery charger into an electrical outlet.

(For CB-2LTE)

Attach the power cord to the battery charger and plug it into an electrical outlet.

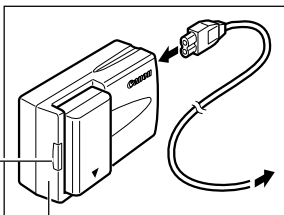

CB-2LTE
Charging Indicator

(For CB-2LT and CB-2LTE)

- The charging indicator will shine orange while the battery pack is charging. It will change to a steady green when the charge is complete.
- After charging, unplug the battery charger and remove the battery pack from it.



- To protect and prolong the life of the battery pack, do not charge it for 24 hours or longer at a time.



- This is a lithium ion battery pack so there is no need to completely use or discharge it before recharging. It can be recharged at any time.
- It takes approximately 80 minutes to bring a fully discharged battery pack to full charge (based on standard Canon testing criteria). Charge it within a temperature range of 5 to 40° C (32 to 104° F).
- Charging times will vary according to the surrounding humidity and battery pack charge state.
- You may hear a noise during charging. This is not a malfunction.

Charging the Battery Pack (continued)

Battery Pack Handling Precautions

- Keep the battery pack and camera terminals (\oplus Ⓜ \ominus) clean at all times. Dirty terminals may cause a poor contact between the battery pack and camera. Polish the terminals with a tissue or a dry cloth before charging or using the battery pack.
- Do not cover the battery charger with anything, such as a tablecloth, cushion or blanket, when it is charging. Heat will build up internally and possibly lead to fire.
- Do not charge batteries other than Battery Pack NB-2L with the supplied battery charger.
- The battery pack continues to discharge a small amount when left in the camera (even with the power turned off) or battery charger. This shortens the battery life. Remove it from the camera, attach the supplied terminal adapter and store it at room temperature (30° C/86° F or less) in a dry place. Charge it before use.
- Even charged battery packs continue to discharge naturally. You are advised to charge the battery on the day of use, or one day before, to ensure a full charge.
- Since storing a fully charged battery pack for long periods of time (about 1 year) can shorten its lifecycle or affect performance, you are recommended to use the battery pack in the camera until it is completely discharged and to store it at room temperature (30° C/ 86° F or less). If you do not use the battery pack for long periods of time, charge it fully and discharge it fully in the camera at least once a year before returning it to storage.
- The camera consumes the battery charge when the power is on even when a function is not being used. To conserve the battery charge, be particularly attentive in turning the camera off.
- Although the battery pack's maximum operating range is 0 to 40° C (32 to 104° F), the optimal range is 10 to 30° C (50 to 86° F). At cold temperatures, such as those experienced when skiing, performance will temporarily decline, reducing the usable time before recharging.
- If the usable time of a battery pack diminishes substantially even when fully charged, it should be replaced.

Installing the Battery Pack

Install Battery Pack NB-2L (supplied) into the camera as follows. Use a household power source to power the camera for extended periods (p. 19).

1 Turn off the camera (p. 27, 29).

- Check that the power/mode indicator is not lit.

2

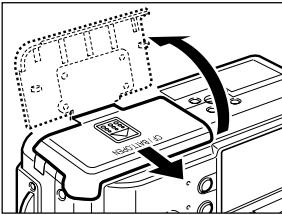

Slide the CF card slot/battery cover in the direction of the arrow to open the cover.

3

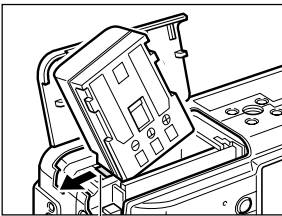

Battery lock

Hold back the battery lock in the direction of the arrow with the corner of the battery pack, then insert the battery pack into the compartment until it is locked.

- To remove the battery pack, release the battery lock.

4

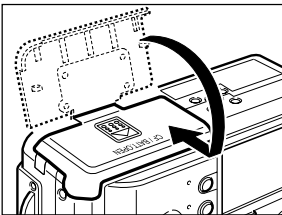

Close the CF card slot/battery cover then slide it to the original position until it clicks.







- Charge the battery pack before using it the first time (p. 15).
- When the upper indicator on the left side of the viewfinder is flashing green, the CF card is being written to, read, erased or transmitted to. Therefore, never turn off the camera or open the CF card slot/battery cover while this indicator is flashing green.
- Remove the battery pack when the camera is not in use.

Installing the Battery Pack (continued)



Battery Low Status

The following icon and/or message appears when the battery becomes low.

	<p>Battery pack charge is low. Recharge it as soon as possible before it is required for an extended period.</p> <p>When the LCD monitor is off, this icon will display when you press the DISPLAY, ,  or  button.</p>
<p>Change the battery pack</p>	<p>Battery charge is insufficient to operate the camera. Replace the battery pack immediately.</p>

Battery Performance (Battery Pack NB-2L at full charge)

	Number of Images Shot		Replay Time
	LCD Monitor On	LCD Monitor Off	
PowerShot S30	Approx. 160 images	Approx. 390 images	Approx. 150 minutes
PowerShot S40	Approx. 180 images	Approx. 420 images	Approx. 150 minutes

* The data above reflects standard Canon testing conditions. The actual figures will vary according to the shooting conditions and settings.

* Movie data is excluded.

* At low temperatures, the battery pack performance may diminish and the low battery icon appear very rapidly. In these circumstances, the performance can be improved by warming the battery pack in a pocket before use.

<Test Conditions>

Shooting: Room temperature (23° C, 73° F), alternating maximum wide angle and maximum telephoto shots at 20-second intervals with flash fired once every four shots and camera power turned off and on every eighth shot. CF card used.

Replaying: Room temperature (23° C, 73° F), continuous playback at one image per 5 seconds. CF card used.

Using a Household Power Source

You are advised to use AC Adapter Kit ACK700* (optional) for long periods of use and when connecting to a computer or printer.

* Consists of Compact Power Adapter CA-P5700, DC Coupler DR-700 and a power cord.

1

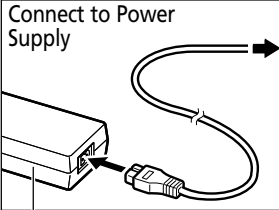

Compact Power Adapter
CA-P5700

Attach the power cord to the compact power adapter and plug it into an electrical outlet.

2

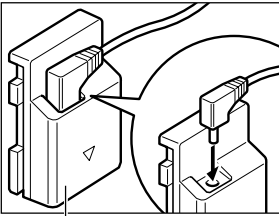

DC Coupler DR-700

Connect the DC plug of the compact power adapter cable to the DC Coupler DR-700 terminal.

3

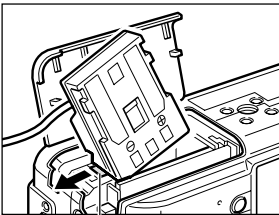

Battery lock

Open the CF card slot/battery cover, then insert the DC Coupler until it is locked.

4

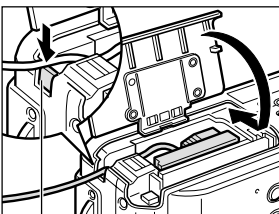

DC Coupler Cable Cover

Press and hold the DC Coupler cable cover using the cable, then close the CF card slot/battery cover.

- Always disconnect the power cord from the power supply after use.

Using a Household Power Source (continued)



- Always turn the camera's power off before connecting or disconnecting the compact power adapter.
- Use of any adapter other than AC Adapter Kit ACK700 may cause malfunction of the camera or AC adapter kit.

Installing a CF Card

- 1 Turn off the camera (p. 27, 29).
 - Check that the power/mode indicator is not lit.

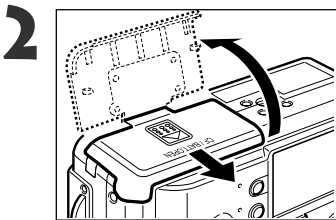

Slide the CF card slot/battery cover in the direction of the arrow to open the cover.

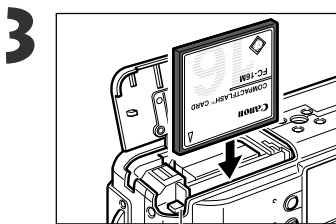

Insert the CF card with the label facing out and the arrow pointing in.

- Push the card in until the CF card eject button fully extends.
- To remove the CF card, push the CF card eject button and pull the card out.

















CF card Eject Button







- When the indicator on the left side of the viewfinder flashes green, the camera is writing, reading, erasing or transmitting an image to or from the card. Do not perform the following, for image data may be lost or corrupted:
 - Do not shake the camera.
 - Do not turn off the power or open the CF card slot/battery cover.
 - Do not remove the CF card.
- Never open the CF card slot/battery cover when the power is on.
- Please note that CF cards formatted in or edited with other manufacturer's cameras or application programs may not operate correctly in the camera.

Installing a CF Card (continued)

CF Cards and Estimated Capacities (Recordable Images)

			FC-8M	FC-16M	FC-32M	FC-64M	FC-128M
L (Large)	PowerShot S30 2048 x 1536 pixels		4	8	18	38	76
			8	16	33	68	137
			16	32	68	136	274
	PowerShot S40 2272 x 1704 pixels		3	7	14	30	61
			6	13	27	54	110
			13	26	54	110	220
M 1 (Medium)	1600 x 1200 pixels		7	14	30	61	123
			13	26	54	109	219
			26	52	108	217	435
M 2 (Medium)	1024 x 768 pixels		12	25	53	107	215
			23	46	94	189	379
			42	84	174	349	700
S (Small)	640 x 480 pixels		29	58	120	241	483
			47	94	196	394	789
			83	165	337	677	1355
RAW	PowerShot S30 2048 x 1536 pixels		2	5	11	24	49
	PowerShot S40 2272 x 1704 pixels		1	4	10	20	42
Movie	320 x 240 pixels		30 sec	61 sec	124 sec	250 sec	502 sec
	160 x 120 pixels		112 sec	223 sec	457 sec	916 sec	1834 sec

- These figures reflect standard shooting conditions established by Canon. Actual totals may vary according to the subject, shooting conditions and shooting mode.
- The following are the approximate maximum recording times for movie clips:
 : 30 seconds,  : 120 seconds. The maximums in the chart reflect continuous shooting.
-  (Superfine),  (Fine) and  (Normal) indicate the relative compression ratio.

CF Card Handling Precautions

- CF cards are high-precision electronic devices. Do not bend, force, or subject them to shocks or vibration.
- Do not attempt to disassemble or alter a CF card.
- Moving a CF card rapidly between temperature extremes may cause condensation to form in the card, leading to potential malfunctions. To avoid condensation formation, place the CF card in a sealed plastic bag before moving it into a different temperature zone and allow it to adjust slowly to the new temperature. If condensation forms on the CF card, put it aside until the water droplets have evaporated completely.
- Place the CF card in the supplied case for storage.
- Do not use or store CF cards in the following types of locations.
 - Locations subject to dust or sand
 - Locations subject to high humidity and high temperatures

Microdrives are a recording medium with a hard disk. Their merits are a large capacity and a low price per megabyte of capacity. However, they are relatively more susceptible to vibrations and shocks than CF cards, which use durable flash memories. Please be careful, therefore, not to subject the camera to vibrations or shocks when using a microdrive, especially while recording or replaying.

Setting the Date / Time

The Set Date/Time menu will appear the first time the camera power is turned on or whenever the built-in rechargeable lithium battery charge is low. Start from Step 5 to set the date and time.

1 Turn on the camera (p. 27).

2 Press the **MENU** button.

- The [📷] (Rec.) or [▶] (Play) menu appears.

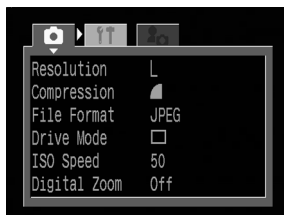

📷 (Rec.) Menu.

3 Select the [⚙️] (Set up) menu using ▶ on the multicontroller.

- Pressing the **JUMP** button also switches between menus.



4 Select [Date/Time] using ▲ or ▼ on the multicontroller, then press **SET**.

- The factory default for the date format may differ from that shown here in some regions.

5 Set the date and time.

- Select the item using ◀ or ▶ on the multicontroller.
- Set the values using ▲ or ▼ on the multicontroller.
- The date can be set up to the year 2030.

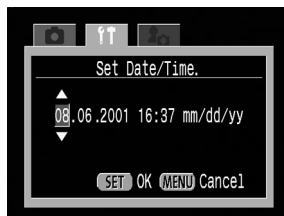

6 Press **SET**.

- After adjusting the settings, press the **MENU** button to close the menu window.





- You may need to reset the date and time if the battery pack is removed for about three weeks.

Setting the Language



1 Turn on the camera (p. 27).

2 Press the **MENU** button.

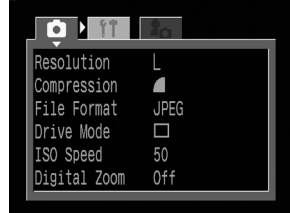
- The  (Rec.) or  (Play) menu appears.







 (Rec.) Menu.

3 Select the  (Set up) menu using  on the multicontroller.

- Pressing the **JUMP** button also switches between menus.



4 Select [Language] using  or  on the multicontroller and press **SET**.

5 Select a language using  or  on the multicontroller.



6 Press **SET**.

- After adjusting the settings, press the **MENU** button to close the menu window.



• In replay mode, you can change the language by holding **SET** while you press the **JUMP** button, except when Card Photo Printer CP-10 (optional) or Bubble Jet Printer with the direct print function (optional) is connected.

Attaching the Strap

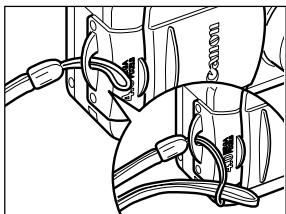

Thread the small loop of the wrist strap through the strap holder on the camera and pull the large loop through the small loop until the strap is firmly secured.



- Avoid waving the camera about or catching it on other items when suspending it from the strap.

Using the Soft Case (Optional)

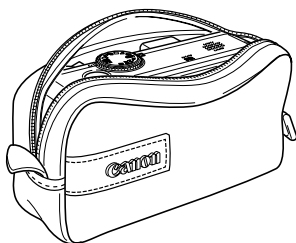

The soft case can be used to carry the camera, battery pack and CF card.

- Optional soft case appearance and specifications may vary according to region.

Turning the Power On / Off

The power/mode indicator remains lit while the power of the camera is on. The power/mode indicator indicates the state of the camera as follows.

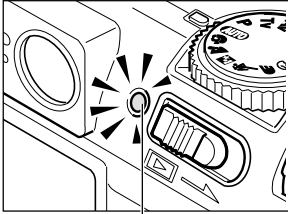

Power/Mode Indicator

- Orange: Shooting mode
- Green: Replaying mode/Printer connection mode*
- Yellow: Computer connection mode*
- Off: The power of the camera is off.

* For printer connection mode, see Printing with Card Photo Printer CP-10 (Optional) (p. 112) and Printing with Bubble Jet Printer with Direct Print Function (Optional) (p. 121).
For computer connection mode, see Software Starter Guide supplied with the camera.

Turning On/Off the Camera in Shooting Mode

1

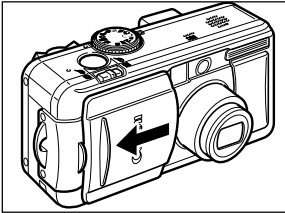

Open the lens cover.

- The camera powers up in Shooting mode.
- The power/mode indicator shines orange.

Close the lens cover.

- The power goes off.

Turning On/Off the Camera in Replaying Mode

1

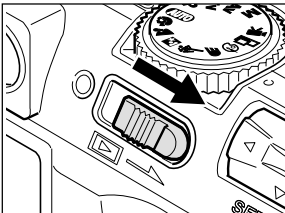

Slide the power/replay lever to the right and hold its position until an image appears on the LCD monitor, then release it.

- The camera powers up in Replaying mode.
- The power/mode indicator shines green.

Slide the power/replay lever to the right again.

- The power goes off.

Turning the Power On / Off (continued)



- You will hear a startup sound and see the startup image when the power comes on. (To change the startup sound and image, see below and pages 41 and 139.)
- The startup image does not appear when the LCD monitor is off or the **A/V OUT** terminal is connected to a TV.



Turning on the camera without the startup sound and image

Press and hold the  button, then turn on the power.

Power Save Function

The camera is equipped with a power save function. If [Auto Power Down] is set to [Off], the power goes off according to the following conditions.

Shooting Mode: Powers down approximately three minutes after the last time a camera control is accessed. The LCD monitor will shut off approximately three minutes after the last time a camera control is accessed even if the power save function is turned off.

Replaying Mode: Powers down approximately five minutes after the last time a camera control is accessed.

Printer Connection Mode: Powers down approximately five minutes after the last time a camera control is accessed on the camera or something is printed on the printer.

PC Connection Mode (The power save function always works regardless of the setting of the camera.):

Displays a warning message on the computer screen approximately 5 minutes after a control is last accessed. The camera will power down if no controls are used after 1 additional minute.

- The following are the ways to restore the power.
 - If the power save function is activated while the camera is in Shooting mode, press the shutter button halfway.
 - If the power save function is activated while the camera is in Replaying mode, slide the power/replay lever to the right again.
- Please note that the camera continues to consume a minimal amount of power even when the power save function shuts it down.
- The power save function is disabled while a slide show plays on the camera (p. 99).
- You can turn off the power save function in the **[Fn] (Set up)** menu (p. 138).

Switching between Shooting and Replaying

You can quickly switch between Shooting mode and Replaying mode. This is convenient when you wish to shoot again after checking or deleting an image immediately after it is shot.

● Shooting Mode

1 Slide the power/replay lever to the right (p. 27).

- The camera is switched to Replaying mode. In this case, the lens does not retract.
- To return to Shooting mode, slide the power/replay lever to the right again or press the shutter button halfway.

● Replaying Mode (With the Lens Cover Closed)

1 Open the lens cover (p. 27).

- The camera is switched to Shooting mode.



Relationship of the Three States (Power Off/Shooting Mode/Replaying Mode) of the Camera

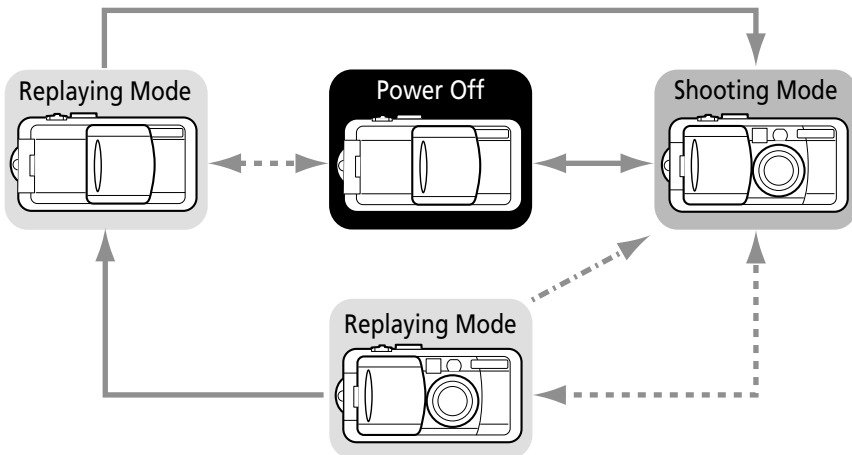

----- : Sliding the Power/Replay lever to the right

————— : Opening/Closing the Lens Cover

..... : Pressing the Shutter Button Halfway

Switching the LCD Monitor Display Mode

The LCD monitor can be used to confirm an image during shooting, to replay recorded images or to adjust menu settings. Pressing the **DISPLAY** button switches the LCD monitor display mode.

● Shooting Mode

- Pressing the **DISPLAY** button cycles the LCD monitor to the next mode each time the button is pressed.

On (No Information) → On (Information View) → Off
↑



- The on/off setting of the LCD monitor display mode is memorized when the camera is turned off. When the camera is turned on again it assumes the last mode. However, when the LCD monitor is turned on and the “Change the Battery Pack” message appears, the LCD monitor may not automatically turn on the next time the camera is started.
- Changing the shooting mode will cause the LCD monitor to display relevant information for about six seconds when it is turned on regardless of whether the information view mode is on or off.
- Setting the mode dial to , or turns on the LCD monitor regardless of whether it is set to on or off.



- The camera shake warning icon will appear at the center of the LCD monitor in low light conditions while the camera is preparing to shoot. When this icon appears, use the flash or fix the camera to a tripod to shoot.

● Replaying Mode

- The LCD monitor turns on when you turn on the camera in Replaying mode (p. 27).
- Pressing the **DISPLAY** button cycles the information view mode each time the button is pressed.

Single Replay: Simple Display → Detailed Display → No Display
↑

Index Replay: Simple Display ↔ No Display

Information Displayed on the LCD Monitor

The LCD monitor displays information in Shooting or Replaying mode, such as the camera settings, remaining image capacity and shooting date / time.

● Shooting Mode

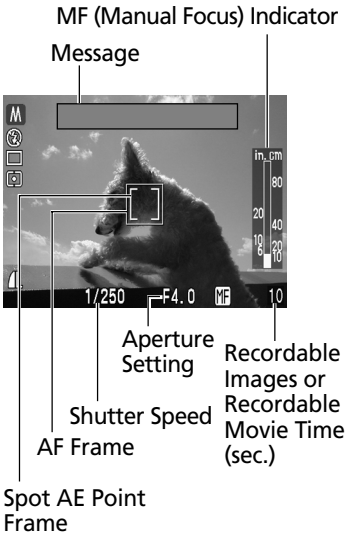

The following displays in information view.

	Shooting Mode	p. 13
	Flash	p. 47
	Drive Mode	p. 58, 59
	Light Metering Method	p. 82
	White Balance (WB)	p. 74
	Exposure Compensation	p. 73
	AEB Mode	p. 77
	Flash Exposure Compensation	p. 78
	Compression Settings	p. 61
	Resolution Settings	p. 61
	File Format	p. 64
	AE Lock/FE Lock	p. 79, 81
	Movie Recording Mode	p. 56
	Macro Mode	p. 57
	Manual Focus	p. 85, 86
	Digital Zoom Setting*	p. 60
	Camera Shake Warning	p. 30
	Low Battery	p. 18

- The icons in the shaded boxes above appear even when the information view is turned off.
- In addition to the above, the message, shutter speed, AF frame, Spot Light Metering Frame, aperture setting and MF indicator (when manual focus is selected) are shown as in the example to the left.

* Zoom powers reflect the combined optical and digital zoom effects. These figures appear when the digital zoom is activated.

Switching the LCD Monitor Display Mode (continued)

● Replaying Mode

File Number

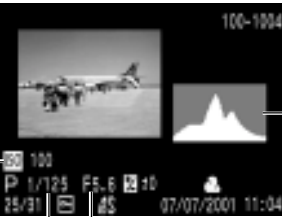

Image Number and Total
(Display Image/
Total)

Shooting
Date / Time

In simple display mode, the following information appears.

	Compression Settings	p. 61
L M1 M2 S	Resolution Settings	p. 61
RAW	File Format	p. 64
	Sound annotation (wav file)	p. 98
AVI	Movie	p. 96
	Protection Status	p. 103



Aperture Setting

Shutter Speed

ISO Speed Setting

Histogram

In detailed display mode, the following information also appears.

	Shooting Mode	p. 13
	Resolution Settings	p. 61
	Exposure level	p. 73
	Flash Exposure Compensation	p. 78
	White Balance	p. 74
	Light Metering Method	p. 82
	Macro Mode	p. 57
MF	Manual Focus	p. 85, 86

- In addition to the above, the ISO speed, shutter speed, aperture setting, histogram and overexposure warning appear.



About the Histogram

The histogram is a graph that allows you to judge the brightness of the recorded image. The greater the bias toward the left in the graph, the darker the image. The greater the bias toward to the right, the brighter the image. If the image is dark, adjust the exposure compensation to a positive number. Similarly, adjust the exposure compensation to a negative number if the image is bright (p. 73).

Histogram Examples

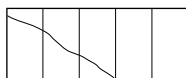

Dark Image

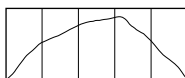

Balanced Image



Bright Image

Overexposure Warning

In detailed display mode, overexposed portions of the image flash. You can use the histogram as a guide to set the exposure compensation to a negative setting and retake the image.

The following information may also appear with some image files.

	An audio file other than a wav file, or a file with an unrecognized format, is attached.
	A JPEG file not supported by "Design rule for Camera File system" (DCF) standards.
	A file with an unrecognized format.



- Please note that image information recorded by this camera may not display correctly on other cameras and image information recorded by other cameras may not display correctly on this camera.

Notice Concerning Shooting

When using this camera to shoot scenes containing extremely bright subjects, a vertical, red bar of light may appear on the LCD monitor. It will not be recorded when shooting still photos, but will be recorded when shooting movies. This is a normal occurrence in devices containing CCDs and does not constitute a malfunction.

Pressing the Shutter Button

The shutter button features a two-stage action.

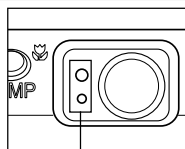
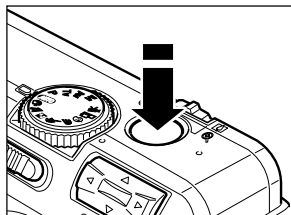

Indicators

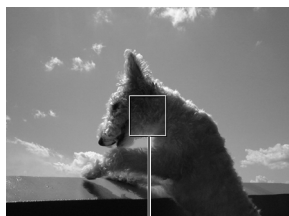

AF Frame

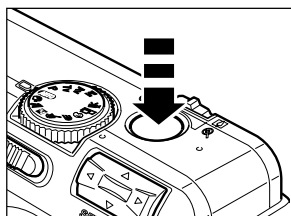

● Pressing Halfway

Pressing halfway automatically sets the exposure, focus and white balance.

- The indicators shine or flash as follows.
 - Green: Metering complete (two beeps sound)
 - Orange: Flash will fire
 - Flashing Orange: Camera shake warning / Insufficient exposure
 - Yellow: Macro mode/Manual focus mode
 - Flashing Yellow: Focusing difficulty* (single beep sounds)
- * Use the focus lock, or focus manually, to shoot when the indicator flashes yellow (p. 86).
- The AF frame appears as follows when the LCD monitor is on.
 - Green: Metering complete
 - Yellow: Focusing difficulty

● Pressing Fully

Pressing fully releases the shutter.

- The upper indicator flashes green while the image is recording onto the CF card.
- You will hear the shutter sound when the shot is complete. Do not move the camera until you hear this sound.



- If the orange or yellow indicator flashes while you press halfway, you can still press fully to take the shot.
- Images are first saved into the camera's internal memory before being recorded onto the CF card, allowing the next images to be taken immediately as long as sufficient space is available in the internal memory.
- The beep and shutter sound can be set On / Off in the Set up menu (p. 116).
- When the shutter sound is set to Off, but the beep is set to On, one beep will sound when the shutter button is fully pressed.
- There is no shutter sound in movie mode.

Using the Optical Viewfinder to Shoot

The camera is equipped with an optical viewfinder.

- Align the square brackets (autofocus metering field) inside the viewfinder on the primary subject to compose the image.
- The viewfinder has a field of vision of approximately 82% of the actual shooting image.

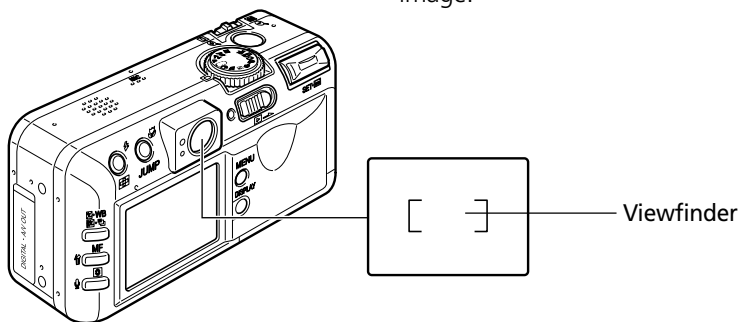

The Parallax Phenomenon

Please note that the actual image may differ from the image seen in the optical viewfinder due to the physical separation between the viewfinder and lens. This is called the parallax phenomenon and is more noticeable the closer the subject is to the lens. In some cases, portions of images shot up close that appear in the viewfinder will not appear in the recorded image. You are recommended to use the LCD monitor to shoot images up close.

Shooting with an Off-Center AF Frame Selected



You should always use the LCD monitor to compose images when you have selected an off-center AF frame (p. 71).

Adjusting the Zoom (Focal Length)

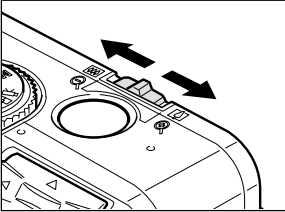
The focal length can be adjusted from 7.1 to 21.3 mm (equivalent to 35 to 105 mm in 35 mm film format).



Telephoto / Wide Angle

- Slide the zoom lever toward  to zoom in (telephoto).
- Slide the zoom lever toward  to zoom out (wide angle).





e.g. PowerShot S40

Digital Zoom

- An image already zoomed with the optical zoom lens can be further zoomed digitally up to an approximate factor of 10 for PowerShot S30, and 11 for PowerShot S40, for shooting (p. 60).



- The digital zoom cannot be used with the LCD monitor turned off or in  or  mode.



- The more the image is zoomed digitally, the coarser its image quality becomes.

Selecting Menus and Settings

Menus are used to adjust shooting, replaying, date / time and electronic sound settings. Watch the LCD monitor while performing the following procedures.

1 Press the **MENU** button.

- In Shooting mode, the [📷 (Rec.)] menu appears. In Replaying mode, the [📺 (Play)] menu appears.

2 Switch between menu tabs using ◀ or ▶ on the multicontroller.

- The menu switches as follows:
[📷 (Rec.)] ↔ [📺 (Play)] ↔ [⚙️ (Set up)] ↔ [👤 (My Camera)]
- Pressing the **JUMP** button also switches between the menu tabs.



3 Select a menu item using ▲ or ▼ on the multicontroller.



4 Select setting contents using ◀ or ▶ on the multicontroller.

- Press **SET** for items followed by an ellipsis (...) then select a setting. Press **SET** again to confirm the setting.



5 Press the **MENU** button.













- Pressing the **MENU** button closes the menu and makes the settings take effect.
- In Shooting mode, the menu can be closed by pressing the shutter button halfway.

















- If the camera is protected by Digital Camera Waterproof Case WP-DC300 (optional), select a menu item using ◀ or ▶ after pressing and holding the **MF** button.

Menu Settings and Factory Defaults



This chart shows the options for each menu and the default settings.

Menu Item		Available Settings	Reference Page
 Rec. Menu (Red)	Resolution (Still picture)	PowerShot S30 L 2048 x 1536 / M1 1600 x 1200 / M2 1024 x 768 / S 640 x 480	p. 61
		PowerShot S40 L 2272 x 1704 / M1 1600 x 1200 / M2 1024 x 768 / S 640 x 480	
	Resolution (Movie)	 320 x 240* /  160 x 120	p. 61
	Compression	 (Superfine) /  (Fine*) /  (Normal)	p. 61
	File Format	JPEG* / RAW	p. 64
	Drive Mode	 * /  /  /  / 	p. 58, 59
	ISO Speed	50* / 100 / 200 / 400 / 800 / AUTO (ISO 800 available on PowerShot S30 only)	p. 87
	Digital Zoom	On / Off*	p. 60
	Spot AE Point	Center* / AF Point	p. 82
	Review	Off / 2 sec.* / 10 sec.	p. 46
	File No. Reset	On / Off*	p. 89
	Contrast	- / 0* / +	p. 87
	Sharpness	- / 0* / +	p. 87
	Saturation	- / 0* / +	p. 87
 Play Menu (Blue)	Protect	Turns image protection on and off	p. 103
	Rotate	Rotates the image in the display	p. 97
	Erase all	Erases all images on the CF card	p. 105
	Slide Show	Replays selected images in a slide show	p. 99
	Print Order	Sets the print settings	p. 107
	Transfer Order	Sets the transfer settings	p. 130

Selecting Menus and Settings (continued)

	Menu Item	Available Settings	Reference Page
f Set up Menu (Yellow)	Beep	On* / Off	p. 137
	LCD Brightness	Normal / Bright*	p. 137
	Speaker Vol.	Off / 1 / 2* / 3 / 4 / 5	p. 137
	Auto Power Down	On* / Off	p. 138
	Date/Time	Sets the date and time	p. 24
	Format	Formats the CF card	p. 106
	Language	English* / Deutsch / Français / Nederlands / Dansk / Suomi / Italiano / Norsk / Svenska / Español / Chinese / Japanese	p. 25
	Video System	NTSC / PAL	p. 138
My Camera Menu (Blue)	Start-up Image	 / 1* /  / 	p. 41, 139
	Start-up Sound	 / 1* /  / 	p. 41, 139
	Shutter Sound	 / 1* /  / 	p. 41, 139
	Operation Sound	 / 1* /  / 	p. 41, 140
	Selftimer Sound	 / 1* /  / 	p. 41, 140

* Default values. Default languages and video system settings vary between regions.



- Some menu items are not available in certain shooting modes.
- You can apply a desired image and sound to  and  in the [ (My Camera)] menu by connecting the camera to the computer. For details, see Software Starter Guide.
- The default of all the settings changed by the menu and button operations except for [Date/Time], [Language] and [Video System] can be restored all at once (p. 141).

Customizing the Camera (My Camera Settings)

My Camera allows you to customize the start-up image and start-up, shutter, operation and self-timer sounds. Each menu item has three choices.

e.g. Start-up image



-  Default camera theme
-  Science fiction theme
-  Animal (bird or dog) theme



Changing My Camera Settings

1 Turn on the camera (p. 27).

2 Press the **MENU** button.

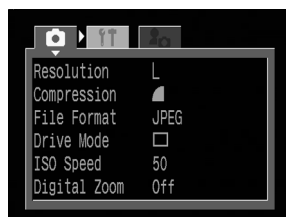

- The  (Rec.) or  (Play) menu appears.



3 Select the  (My Camera) menu using  on the multicontroller.

- Pressing the **JUMP** button also switches between the menu tabs.



4 Select a menu item using  or  on the multicontroller.

Changing My Camera Settings (continued)

- 5** Select setting content using ◀ or ▶ on the multicontroller.

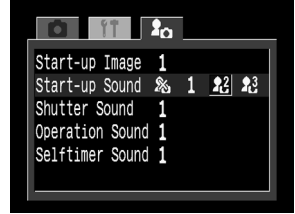

- 6** Press the **MENU** button.

- Pressing the **MENU** button closes the menu and makes the settings take effect.
- In Shooting mode, the menu can be closed by pressing the shutter button halfway.

.....



- If [Beep] in the [f1] (Set up) menu is set to [On], the beep sounds even if each sound item such as [Start-up Sound], [Shutter Sound], [Operation Sound] and [Selftimer Sound] in the [f2] (My Camera) menu is set to [Beep] (Off) (p. 140).

Customizing My Camera Settings

You can customize the contents of menu [L3] and [L8] using the supplied software and storing these to your camera.

File format of My Camera Settings

● Start-up Image

- Recording image format JPEG (Base line JPEG)
- Sampling rate 4 : 1 : 1
- Image size 320 x 240 pixels
- File capacity 20 KB or less

● Start-up Sound, Shutter Sound, Operation Sound and Selftimer Sound

- Recording format WAVE (monaural)
- Standardizing bit 8 bit
- Sampling frequency 11.025 kHz and 8.000 kHz
- Recording time

	11.025 kHz	8.000 kHz
Start-up Sound	1.0 sec. or less	1.3 sec. or less
Shutter Sound	0.3 sec. or less	0.4 sec. or less
Operation Sound	0.3 sec. or less	0.4 sec. or less
Selftimer Sound	2.0 sec. or less	2.0 sec. or less

Any file format other than those described above cannot be used with this camera.

An example of this function is to record "Say cheese" as the Selftimer sounds so the camera will replay this sound two seconds before the photo is taken.

See the Software Starter Guide of the supplied software as well as the ZoomBrowser EX or ImageBrowser Software Guide (both are in pdf format) included in the Solution Disk.

Shooting - Letting the Camera Select Settings

AUTO Auto Mode

In this mode, all you have to do is press the shutter button and let the camera do everything else.

1 Check that the camera is in Shooting mode (p. 27).

2 Turn the shooting mode dial to **AUTO**.

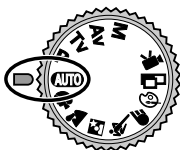

3 Aim the camera at the subject.

4 Use the zoom lever to achieve the desired composition (relative subject size in the viewfinder).

5 Press the shutter button halfway (p. 34).

- Two beeps will sound when the camera has finished metering, and the indicator beside the viewfinder will shine green or orange. If the LCD monitor is on, the AF frame will appear green.
- The shutter speed and aperture settings are automatically determined and show on the LCD monitor if it is on.
- The yellow indicator will flash and the beep will sound one time if the subject is difficult to focus on. The AF frame will also appear yellow.

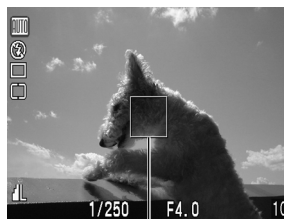

AF Frame

6 Press the shutter button all the way (p. 34).

- You will hear the sound of the shutter when the shutter activates.
- The picture appears for two seconds on the LCD monitor, if it is on.



- You can change the following settings.

Resolution	L (Large)* / M1 (Medium 1) / M2 (Medium 2) / S (Small)
Compression	(Superfine) / (Fine) / (Normal)
Flash Settings	(Red-Eye Reduction Auto)* / (Auto) / (Off)
Macro	Off* / On
Digital Zoom	On / Off*
Drive Mode	* / /
Review	Off / 2sec.* / 10sec.
File No. Reset	On / Off*

* Default settings

- With the Review function, you can change the length of time images show on the LCD monitor after shooting, or set it so they do not show at all (p. 46).

Checking an Image Right after Shooting

Checking the Image

After a photo is taken, the image displays on the LCD monitor for two seconds. There are two ways to display the image for longer.

● Keeping the Shutter Button Pressed

The image continues to appear on the LCD monitor as long as you keep the shutter button fully depressed.

● Pressing SET

If you press **SET** while the image is displayed on the LCD monitor, it will continue to display even after the shutter button is released. Press the shutter button halfway again to stop displaying it.

.....



- You can perform the following while images are displayed.
 - Erasing Images Singly (p. 9, 104)
 - Displaying Images in detailed display mode (p. 30)
 - Magnifying Images (p. 93)
 - Attaching Sound Annotations (p. 98)

Changing the Image Display Duration

The length of time images are displayed after a photo has been taken can be changed from 2 seconds to 10 seconds or turned off.

1 In the [CAM (Rec.)] menu, select [Review].

- See Selecting Menus and Settings (p. 38).



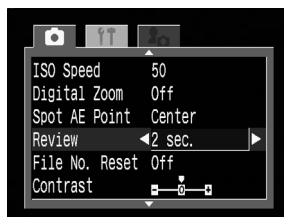

2 Select a Review setting and press the **MENU** button.

- With the [Off] option, the image will not automatically display.
- With the [2 sec.] or [10 sec.] options, the image will appear for the time selected.
- You can continue to display the image as long as the shutter button is fully held pressed regardless of the Review setting.
- Another picture can be taken even while the last is displayed.



⚡ Using the Flash

Use the flash according to the guidelines below.

	Red-eye reduction, Auto	The flash fires automatically as required by the lighting level, and the red-eye reduction lamp fires each time the main flash fires
	Auto	The flash fires automatically as required by the lighting level.
	Red-eye reduction, Flash on	The red-eye reduction lamp and the flash always fire.
	Flash on	The flash always fires.
	Flash off	The flash does not fire.

1 Press the ⚡ button to switch between flash modes.

- The selected flash mode appears on the LCD monitor.

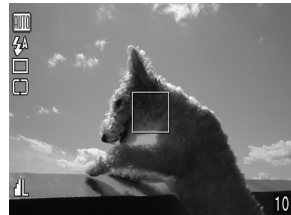













2 Shoot the image.

- The flash will fire if the indicator beside the viewfinder shines orange when the shutter button is pressed halfway.
- Shooting procedures are the same as for the **AUTO** Auto mode (p. 44).

Built-in Flash Settings

The flash cannot be used with some shooting modes.

		AUTO									P	Tv	Av	M
	Red-eye reduction, Auto	●*	●*	●	●*	●	●	●	-	-	●	-	-	-
	Auto	●	●	●	●	●*	●	●*	-	-	●	-	-	-
	Red-eye reduction, Flash on	-	●	●	●	●	●	●	-	-	●	●	●	●
	Flash on	-	●	●	●	●	●	●	▲	-	●	●	●	●
	Flash off	●	●	●*	●	●	●*	●	●*	●*	●*	●*	●*	●*

* Default setting.

● Setting selection is possible.

▲ Setting can only be selected for the first image.

- Setting selection is not possible.

⚡ Using the Flash (continued)



- When shooting with a high ISO sensitivity and using the built-in flash, there is more of a chance of overexposure the closer you are to the subject.



- The fastest shutter speed for flash synchronization is 1/250 second. The camera automatically resets the shutter speed to 1/250 second if a faster speed is selected.
- The flash may take up to approximately 10 seconds to charge in some cases. Actual times will vary according to usage and the battery charge.
- In **M** mode, the flash fires at full intensity. The flash intensity is automatically adjusted except in **M** mode.
- The flash setting is saved when the camera is turned off in the **P**, **Tv**, **Av** and **M** shooting modes.
- The flash will fire twice. A pre-flash will fire and will be followed by the main flash. The pre-flash is used by the camera to obtain the subject's exposure data so that the main flash can be set to the optimal intensity for the shot.



About the Red-Eye Reduction Function

Light reflecting back from eyes can make them appear red when the flash is used in dark areas. Under these conditions, use the red-eye reduction mode. For this mode to be effective, the subject must be looking right at the red-eye reduction lamp. Try asking them to look directly at the lamp. Even better results can be obtained by shooting with the lens set to the wide angle, increasing the lighting in indoor settings or approaching closer to the subject.

Portrait Mode

Use this mode when you want the subject to appear sharp and the background to blur.

1



Turn the shooting mode dial to .

- Shooting procedures are the same as for the **AUTO** Auto Mode (p. 44).



- The AEB, AE lock, FE Lock, light metering, file format (RAW), and image adjustment (ISO speed, contrast, sharpness and saturation) settings cannot be adjusted in this mode.
- You can set the AF frame to either the auto (AiAF) selection or manual center (p. 71).





- To best achieve the effect of the background gradually fading, compose the image so that the upper half of the subject's body fills most of the viewfinder or LCD monitor.
- The background gets increasingly indistinct the more you adjust the focal length toward telephoto.

Landscape Mode

Use this mode to shoot expansive landscape scenes.

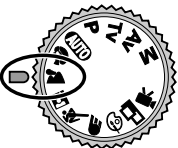
1





Turn the shooting mode dial to .

- Shooting procedures are the same as for the **AUTO** Auto Mode (p. 44).



- The macro, AEB, AE lock, FE Lock, light metering, file format (RAW), and image adjustment (ISO speed, contrast, sharpness and saturation) settings cannot be adjusted in this mode.
- You can set the AF frame to either the auto (AiAF) selection or manual center (p. 71).



- Since a slow shutter speed is often selected in  mode, use a tripod to shoot if the  (camera shake warning) icon appears on the LCD monitor.

Night Scene Mode

Use this mode to capture human subjects against the backdrop of an evening sky or night scene. The people are illuminated with light from the flash while the backdrop is captured at a slow shutter speed so that both appear correctly exposed.

1

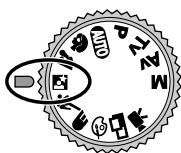

Turn the shooting mode dial to .

- Shooting procedures are the same as for the **AUTO** Auto mode (p. 44).



- The macro, AEB, AE lock, FE Lock, light metering, file format (RAW), and image adjustment (ISO speed, contrast, sharpness and saturation) settings cannot be adjusted in this mode.
- You can set the AF frame to either the auto (AiAF) selection or manual center (p. 71).
- Always use a tripod to prevent camera shake in this mode.





- Warn people to stay still for a few seconds after the flash fires because of the slow shutter speed.
- Using the  mode in daylight will produce an effect similar to that of the **AUTO** mode.

Fast Shutter

Use this mode to shoot fast moving objects such as sports figures.

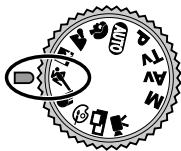
1



Turn the shooting mode dial to .

- Shooting procedures are the same as for the **AUTO** Auto mode (p. 44).



- The AEB, AE lock, FE lock, light metering, file format (RAW), and image adjustment (ISO speed, contrast, sharpness and saturation) settings cannot be adjusted in this mode.
- You can set the AF frame to either the auto (AiAF) selection or manual center (p. 71).





- Noise in the recorded image may increase if you shoot dark subjects.

Slow Shutter

Use this mode to shoot moving objects to make them appear blurred such as river rapids.

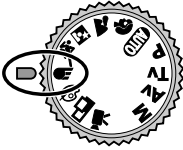
1



Turn the shooting mode dial to .

- Shooting procedures are the same as for the  Auto mode (p. 44).



- The AEB, AE lock, FE lock, light metering, file format (RAW), and image adjustment (ISO speed, contrast, sharpness and saturation) settings cannot be adjusted in this mode.
- You can set the AF frame to either the auto (AiAF) selection or manual center (p. 71).
- Always use a tripod to prevent camera shake in this mode.



Changing the Color Effect

You can shoot with different color effects.

	Vivid	Emphasizes the contrast and color saturation to record in bold color.
	Neutral	Tones down the contrast and color saturation to record neutral hues.
	Sepia	Records in sepia tones.
	B/W	Records in black and white.

1

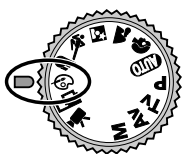

Turn Shooting mode dial to .

- The LCD monitor turns on and displays the color effects menu.

2

Select a color effect using ◀ or ▶ on the multicontroller.

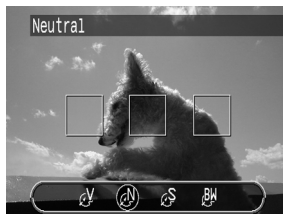

3

Press **SET**.

- You can also press the shutter button directly to shoot instead of pressing **SET**.

4

Shoot the image.

- Shooting procedures are the same as for the **AUTO** Auto mode (p. 44).
- If you press **SET** after shooting, the Setup menu will appear and allow you to change the setting again.

.....



- The AEB, AE lock, FE lock, light metering, file format (RAW), and image adjustment (ISO speed, contrast, sharpness, and saturation) settings cannot be adjusted in this mode.
- The white balance cannot be set when (sepia) or (B/W) mode is selected.
- You cannot change the macro mode setting while the Color Effect Setup menu is displayed.
- The AF frame is set to the auto (AiAF) selection when shooting with the color effect.



Stitch Assist Mode

Use this mode to shoot a series of overlapping frames for merging (stitching) into a large panoramic image using a computer.

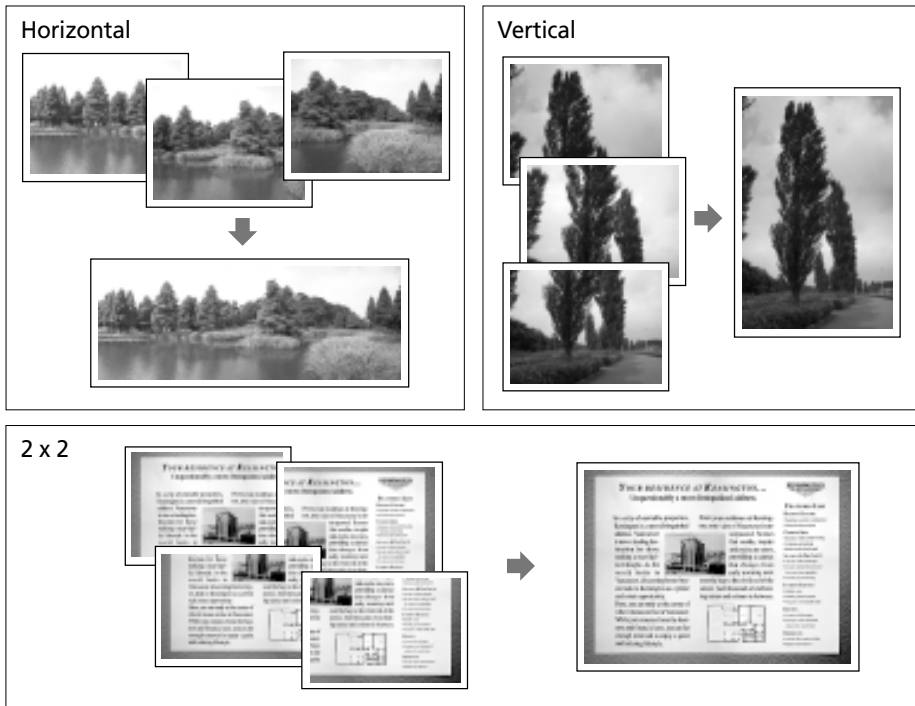

- Please use the bundled PhotoStitch program to merge the images on a computer.

Framing a Subject

PhotoStitch detects the overlapping portions of adjoining images and merges them. When composing shots, try to include a distinctive item (landmark, etc.) in the overlapping portions.

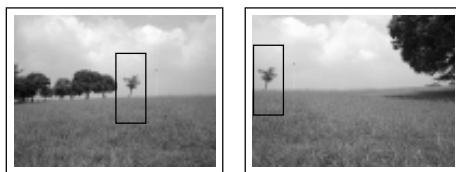



Stitch Assist Mode (continued)



- Compose each frame so that it overlaps 30 to 50% of the adjoining image. Try to keep the vertical misalignment to within 10% of the image height.
- Do not include moving items in the overlap.
- Do not try to stitch images that include both distant and close subjects. Objects may appear warped or doubled up.



To Shoot a Distant Subject

As shown below, swivel the camera around its axis to take successive shots.

Horizontal:
swivel left to right
or vice versa

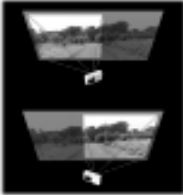

Vertical:
swivel up and down
or vice versa

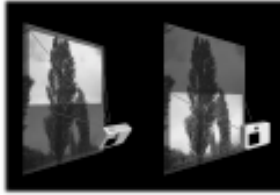

To Shoot a Close Subject

Slide the camera (move the camera parallel to the subject) to take successive shots.

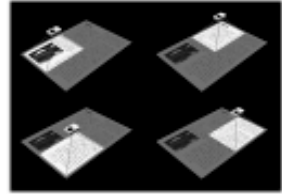

Shooting

Images can be shot in the following 5 sequences in Stitch Assist mode.

	Horizontally, left to right
	Horizontally, right to left
	Vertically, bottom to top
	Vertically, top to bottom
	Clockwise starting at the top left

1

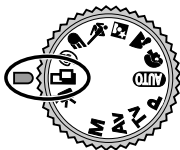

Turn the shooting mode dial to .

- The LCD monitor will turn on.

2

Select the shooting sequence using or on the multicontroller and press **SET**.

- You can also press the shutter button directly to shoot without pressing **SET**.



3 Shoot the first image.

- The exposure and white balance settings are set and locked with the first image.

4 Compose and shoot the second image so that it overlaps the first.

- Minor discrepancies in the overlap can be corrected with the software.
- An image can be retaken. Press ◀ or ▶ on the multicontroller to return to that frame.



Sequence



Sequence

5 Use the same procedures to shoot the remaining frames.

- A maximum of 26 images can be recorded either horizontally or vertically.

6 Press **SET** after the last shot.





- The digital zoom, flash (red-eye reduction auto, auto, red-eye reduction), continuous mode (,), AEB, AE lock, FE Lock, AF frame, light metering, file format (RAW), and image adjustment (ISO speed, contrast, sharpness and saturation) settings cannot be adjusted in this mode.
- A TV cannot be used as the monitor for shooting in this mode.





- The zoom, flash (on / off), resolution, macro mode, exposure, white balance* and flash exposure compensation settings can only be adjusted for the first image. The selected settings are applied to the subsequent images and cannot be changed.
* A custom white balance setting cannot be set in mode. To use a custom white balance setting, first set it in another shooting mode.

Movie Mode

Use this mode to shoot movie frames. The resolution can be set to  320 x 240 pixels (default setting) or  160 x 120 pixels in [Resolution] of the  (Rec.) menu (p. 61).

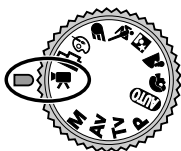
1



Turn the shooting mode dial to .

- The LCD monitor turns on and displays the maximum recording time (in seconds).

2

Press the shutter button all the way.

- Shooting and sound recording starts simultaneously.
- During the shooting a red circle appears in the upper right of the LCD monitor.

3

Press the shutter button all the way to stop recording the movie.

- The maximum length of individual movie clips (approximately 15 frames/second) is about 30 seconds* at the (320 × 240) setting and about 120 seconds* at the (160 × 120) setting. The clip will end automatically after this time elapses or when the CF card becomes full.

* The data reflects standard Canon testing conditions. The actual figures will vary according to the shooting objects and conditions.



- Be careful not to touch the microphone while shooting.
- The AE, AF, white balance and zoom settings are set and locked to the settings of the first frame.
- If the indicator on the left side of the viewfinder flashes green after a shot, this indicates that the movie is being written to the CF card. You cannot shoot again until it stops flashing.
- The digital zoom, flash, continuous mode, AEB, flash exposure compensation, AE lock, FE Lock, light metering, AF mode (single), resolution, compression, file format (RAW), and image adjustment (ISO speed, contrast, sharpness and saturation) settings cannot be adjusted in this mode.



- Sound is recorded monaurally.
- There is no shutter sound in movie mode.





- QuickTime 3.0 or higher is required to replay movie files (AVI / Motion JPEG) on a computer.

Macro Mode

Use the macro mode to shoot close-ups of subjects in the range of 10 to 80 cm (3.9 in. to 2.7 ft.) at maximum wide angle and 30 to 80 cm (1.0 ft. to 2.7 ft.) at maximum telephoto.

1 Press the **DISPLAY** button to turn the LCD monitor on.

2 Press the  button.

- The  icon appears on the LCD monitor.
- Press the  button again to cancel the macro mode.



3 Shoot the image.

- The indicator beside the viewfinder will shine yellow when the shutter button is pressed halfway.
- Shooting procedures are the same as for the **AUTO** Auto Mode (p. 44).



- The macro mode cannot be selected in the  and  shooting modes.



- Always use the LCD monitor to compose images in macro mode. Shooting with the viewfinder is possible, though, the parallax phenomenon (p. 36) may cause images composed with the optical viewfinder to be off-center.
- When the lens is zoomed out to the maximum wide angle, the recordable area is approximately 108 × 80 mm (4.25 in. × 3.15 in.) at the closest focal distance, and at maximum telephoto, it is approximately 111 × 83 mm (4.37 in. × 3.27 in.).
- Use of the built-in flash may not provide an appropriate amount of light.
- Turning the camera off cancels the setting.

Self-Timer

You can take pictures with the self-timer in any shooting mode.

1 In the [📷 (Rec.)] menu, select [Drive Mode].

- See Selecting Menus and Settings (p. 38).

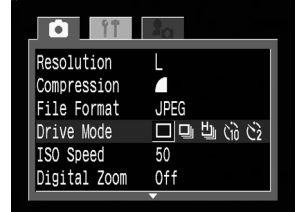

2 Select [🕒] or [🕒], then press the **MENU** button.

- When [🕒] is selected, the shutter release will be delayed for 10 seconds, and when [🕒] is selected, the shutter release will be delayed for 2 seconds, after you press the shutter button.

3 Shoot the image.

- When [🕒] is selected, the self-timer lamp starts flashing when the shutter button is pressed all the way. The self-timer sounds and the flashing gets faster two seconds before the shutter activates.
- When [🕒] is selected, the self-timer lamp flashes fast from the beginning. The shutter activates in two seconds.
- Shooting procedures are the same as for the **AUTO** Auto mode (p. 44).

.....



- Turning the camera off cancels the setting.





.....



- You can change the self-timer sound by changing the setting in [Selftimer Sound] in the [📷 (My Camera)] menu (p. 140).



Continuous Mode

Use this mode to shoot successive frames while the shutter button is fully pressed.

	Standard Continuous Shooting	Use this mode to view the images as you shoot continuously. The shutter interval is longer in this mode than in  mode.
	High Speed Continuous Shooting	Use this mode to shoot continuously with a short shutter interval. The camera's internal memory will become full faster in this mode than in  mode when many frames are shot or when high image quality settings are selected.

1 In the [ (Rec.)] menu, select [Drive Mode].

- See Selecting Menus and Settings (p. 38).

2 Select [] or [], then press the **MENU** button.

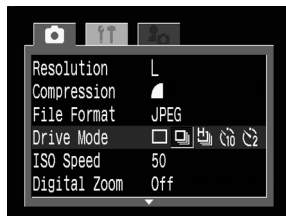

3 Press the shutter button halfway to lock the focus.

4 Press the shutter button all the way to shoot.

- Shooting will stop when the shutter button is released.
- The shooting speed is as follows.*

(PowerShot S30)

When [] is selected: Approx. 2 frames per second

When [] is selected: Approx. 3 frames per second



(PowerShot S40)

When [] is selected: Approx. 1.5 frames per second

When [] is selected: Approx. 2.5 frames per second

* Large/Fine, LCD monitor off mode. (These figures reflect standard Canon testing conditions. The actual figures will vary according to the shooting conditions and settings.)



- This mode cannot be selected in **AUTO**,  or  shooting mode.
- In [] mode, images do not appear on the LCD monitor as they are shot.
- The flash can be used, but the interval between images will lengthen to accommodate the flash recharge time.









- Successive frames can be taken until the CF card is full.
- The interval between frames may lengthen somewhat when the internal memory becomes full.

Digital Zoom

With the combined optical and digital zoom functions, images can be zoomed as follows.

PowerShot S30: 3.8 times, 4.8 times, 6.0 times, 7.4 times, and 10 times

PowerShot S40: 4.3 times, 5.3 times, 6.7 times, 8.2 times, and 11 times

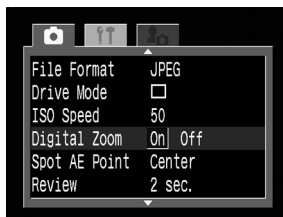

- 1 Press the **DISPLAY** button to turn the LCD monitor on.
- 2 Turn the shooting mode dial to any shooting mode except for  or .
- 3 In the  (Rec.) menu, select [Digital Zoom].
 - See Selecting Menus and Settings (p. 38).
- 4 Select [On] and press the **MENU** button.
- 5 Slide the zoom lever toward  and hold it.
 - The lens will zoom to the maximum optical telephoto setting and stop. Release the lever and slide it toward  again to further zoom the image digitally.
 - Slide the lever toward  to zoom back out.



e.g. PowerShot S40

- 6 Shoot the image.
 - Shooting procedures are the same as for the **AUTO** Auto mode (p. 44).

.....

-  This mode cannot be selected in the  and  shooting modes or for the RAW file format.
- Images become coarser the more they are digitally zoomed.
- The digital zoom On/Off setting is memorized even when the camera power is turned off so you can skip steps 3 and 4 if you wish to use the same option the next time.

The combined magnifications of the optical zoom and digital zoom are displayed.

Shooting - Selecting Particular Effects







Camera settings such as image resolution and compression, shutter speed and aperture can be freely changed for shooting.



- Please see **AUTO** Auto Mode (p. 44) for shooting procedures once you have changed a setting.

Changing the Resolution and Compression



You can change the resolution and compression (excluding movies) settings to suit the purpose of the image you are about to shoot. The resolution gets higher in the order **S** (Small), **M1** (Medium 1), **M2** (Medium 2), and **L** (Large). Use a higher resolution if you wish to make a large print. Conversely, use a lower resolution if you wish to print on small objects, such as labels, to send images electronically, or to fit more images on a CF card.

The compression gets higher in the order  (Superfine),  (Fine) and  (Normal). Select  (Superfine) for a higher quality image, or  (Normal) if you wish to fit more images on a CF card. The  (Fine) setting provides adequate quality for standard shots. To record the CCD output without compression, select the RAW file format (p. 64).

Resolution (excluding)



	PowerShot S30	PowerShot S40
L (Large)	2048 x 1536 pixels	2272 x 1704 pixels
M1 (Medium 1)	1600 x 1200 pixels	
M2 (Medium 2)	1024 x 768 pixels	
S (Small)	640 x 480 pixels	

Resolution ()

	320 x 240 pixels
	160 x 120 pixels

- Common to PowerShot S30 and PowerShot S40

Compression (excluding)

	Superfine
	Fine
	Normal

Changing the Resolution and Compression (continued)

- 1 Turn the shooting mode dial to the desired shooting mode.
- 2 In the **[] (Rec.)** menu, select **[Resolution]** or **[Compression]**.
 - See Selecting Menus and Settings (p. 38).
- 3 Select a resolution or compression setting and press the **MENU** button.

Resolution (excluding )

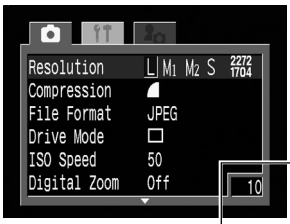

e.g. PowerShot S40

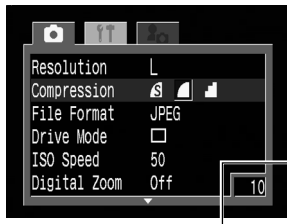

Compression





The number of recordable images (only displayed when the resolution, compression or file format is changed)

- 4 Shoot the image.



Approximate File Size for One Image

PowerShot S30			
L (2048 x 1536)	1602	893	445
M1 (1600 x 1200)	1002	558	278
M2 (1024 x 768)	570	320	170
S (640 x 480)	249	150	84
RAW (2048 x 1536)	2469		



Unit : KB

	(320 x 240)	240
	(160 x 120)	60

Unit : KB / sec.

PowerShot S40			
L (2272 x 1704)	2002	1116	556
M1 (1600 x 1200)	1002	558	278
M2 (1024 x 768)	570	320	170
S (640 x 480)	249	150	84
RAW (2272 x 1704)	2862		

Unit : KB

	(320 x 240)	240
	(160 x 120)	60

Unit : KB / sec.

* This figure reflects standard shooting conditions established by Canon. Actual figures may vary according to the subject and shooting conditions.

* Please see the list of CF cards and their approximate capacities (p. 22).



- In mode, the resolution can be set for the first frame only.
- The resolution and compression settings are affected by the shooting mode selection as follows (only the resolution in mode).

Initial Shooting Mode	Next Shooting Mode	Resolution and Compression after Change
		Settings change to those of the next mode
		Settings do not change
		Settings change to those of the next mode
		Settings do not change
		Settings change to those of the next mode

- The resolution and compression settings are memorized even when the camera power is turned off.

Changing the File Format

The recording file format can be switched to the RAW format. With the standard JPEG file format, the camera processes images after capturing them to produce optimal results. The JPEG format compresses images so that more can be stored on a single CF card. However, the compression is irreversible, meaning that the original image data cannot be recovered after processing. In contrast, the RAW format records the image data as captured by the camera's CCD without further processing. RAW images are compressed, but the compression is reversible* so that a high-quality image can be obtained from the decompressed file without any loss of image quality. In addition, although a RAW file is larger than an equivalent JPEG file, it is still only approximately one-quarter the size** of an uncompressed RGB TIFF format file, making it relatively compact.

With standard uncompressed file formats, such as RGB TIFF, images are processed in the camera and require further processing by retouching software to adjust the image parameters, which reduces image quality. With the RAW format, however, the original data can be used in special software* to adjust the image parameters (white balance, contrast, sharpness and saturation) making it possible to maintain the image quality while making changes. The resolution (PowerShot S30: 2048 x 1536, PowerShot S40: 2272 x 1704) and compression settings cannot be adjusted for these images.

* The bundled software can be used to open or adjust the parameters of images recorded in the RAW file format. Please consult the Software Starter Guide for details.

** As measured by standard Canon test conditions.

1 Turn the shooting mode dial to **P**, **Tv**, **Av** or **M**.

2 In the [📷 (Rec.)] menu, select [File Format].

- See Selecting Menus and Settings (p. 38).

3 Select [RAW] and press the **MENU** button.

- The **RAW** icon appears while the LCD monitor is on.

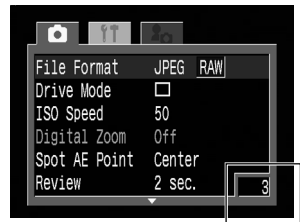

The number of recordable images (only displayed when the resolution, compression or file format is changed)

4 Shoot the image.

.....



- The RAW file format can only be selected in the **P**, **Tv**, **Av** and **M** modes.

P Program AE

Use the program AE mode to have the camera automatically set the shutter speed and aperture settings to match the brightness of the scene.

1

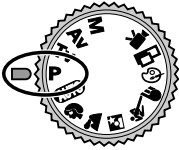

Turn the shooting mode dial to **P**.

2

Shoot the image.

- The shutter speed and aperture settings will be set automatically. They appear on the LCD monitor if it is on.
- The correct exposure has been set if the shutter speed and aperture settings show in white.

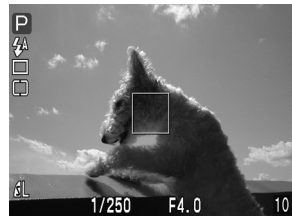

- If a correct exposure cannot be obtained, the shutter speed and aperture settings show in red on the LCD monitor. Use the following methods to make them show in white.
 - Use the flash.
 - Change the ISO speed setting.
 - Change the light metering method.



Differences and Similarities between the P and **AUTO** Modes.

- Both modes automatically select the shutter speed and aperture settings.
- The following settings can be adjusted in **P** mode, but not in **AUTO** mode.
 - Exposure Compensation
 - AEB Mode
 - Flash (Red-Eye Reduction, Flash On)
 - File Format Settings
 - Image Adjustment (ISO Speed, Contrast, Sharpness and Saturation) Settings
 - Change of Light Metering Method
 - Change of AF frame (left or right AF frame)
 - FE Lock
 - White Balance
 - Flash Exposure Compensation
 - Continuous Mode
 - Manual Focus
 - AE Lock
- For the correlation between aperture value and shutter speed, see page 67.

Tv Setting the Shutter Speed

When you set the shutter speed in the shutter speed-priority AE mode, the camera automatically selects an aperture setting to match the brightness. Faster shutter speeds allow you to catch an instantaneous image of a moving subject while slower speeds create a flowing effect and allow you to shoot without a flash in dark areas.

1

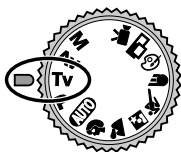

Turn the shooting mode dial to **Tv**.

- The shutter speed appears on the LCD monitor if it is on.

2

Select a speed using ◀ or ▶ on the multicontroller.

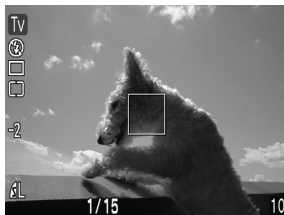

3

Shoot the image.

- The correct exposure has been set if the shutter speed and aperture settings show in white.

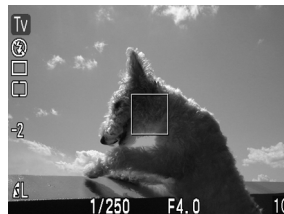

.....



- If the aperture value shows in red, the image is under- or overexposed (insufficient light). Adjust the shutter speed using ◀ or ▶ on the multicontroller until the aperture value display turns to white.
- The nature of CCD image sensors is such that noise in the recorded image increases at slow shutter speeds. This camera, however, applies special processing to images shot at shutter speeds slower than 1.3 seconds to eliminate the noise, thereby producing high-quality images. Nevertheless, a certain amount of processing time may be required before the next image can be shot.



- Please note that camera shake becomes a factor at low shutter speeds. If the camera shake warning  appears in the center of the LCD monitor, secure the camera to a tripod before shooting.
- The aperture value and shutter speed change according to the zoom state as follows.

	Aperture	Shutter Speed (seconds)
Wide Angle	F 2.8 - 3.5	to 1/1000
	F 4.0 - 8.0	to 1/1500
Telephoto	F 4.9 - 6.3	to 1/1000
	F 7.1 - 8.0	to 1/1500

Shutter Speed Display

The numbers in the table below indicate the shutter speed in seconds. For slower speeds, quote marks indicate the decimal place, so that 0"3 indicates 0.3 second and 2" indicates 2 seconds.

1/1500	1/1250	1/1000	1/800	1/640	1/500	1/400	1/320				
1/250	1/200	1/160	1/125	1/100	1/80	1/60	1/50	1/40			
1/30	1/25	1/20	1/15	1/13	1/10	1/8	1/6	1/5	1/4		
0"3	0"4	0"5	0"6	0"8	1"	1"3	1"6	2"	2"5	3"2	4"
5"	6"	8"	10"	13"	15"						

Av Setting the Aperture

When you set the aperture in the aperture-priority AE mode, the camera automatically selects a shutter speed to match the brightness. Selecting a lower aperture value (opening the aperture) allows you to fade the background and create a beautiful portrait. A higher aperture value (closing it) brings the entire range from foreground to background into focus. The larger the aperture value, the greater the range of the image brought into clear focus.

1

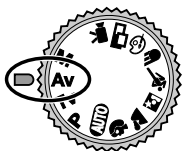

Turn the shooting mode dial to **Av**.

- The aperture setting appears on the LCD monitor if it is on.

2

Select a value using ◀ or ▶ on the multicontroller.

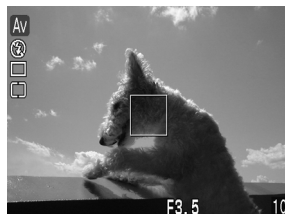

3

Shoot the image.

- The correct exposure has been set if the shutter speed and aperture settings show in white.





- If the shutter speed shows in red on the LCD monitor, the image is under- or overexposed (insufficient light). Adjust the aperture value using ◀ or ▶ on the multicontroller until the shutter speed display turns white.



- Please note that camera shake becomes a factor at low shutter speeds. If the camera shake warning  appears in the center of the LCD monitor, secure the camera to a tripod before shooting.
- When using a flash in this mode, the slowest shutter speed is 1/60 second.

Aperture Setting Display

The larger the aperture value, the smaller the lens aperture.

F2.8 F3.2 F3.5 F4.0 F4.5 F5.0 F5.6 F6.3 F7.1 F8.0



- For the correlation between aperture value and shutter speed, see page 67.

M Manually Setting the Shutter Speed and Aperture

You can manually set the shutter speed and aperture to achieve a particular effect. This is convenient for shooting fireworks and other images where it is difficult to set the correct exposure automatically.

1

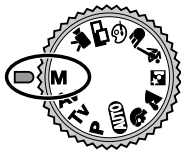

Turn the shooting mode dial to **M**.

- The shutter speed and aperture settings appears on the LCD monitor if it is on.

2

Select a shutter speed using ◀ or ▶ on the multicontroller.

3

Select an aperture setting using ▲ or ▼ on the multicontroller.

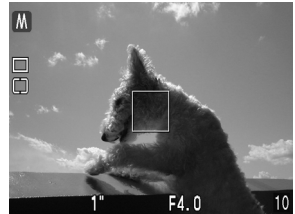

4

Shoot the image.



- When you press the shutter button halfway, a number indicating the difference between the standard exposure* and the selected exposure appears on the LCD monitor. If the difference is more than ± 2 steps, “-2” or “+2” appears in red.

* The standard exposure is calculated by the AE function according to the selected metering method.



- The exposure compensation, AE lock, FE lock, flash exposure compensation, AEB and ISO speed (AUTO) settings cannot be adjusted in this mode.



- If you wish to change the exposure, adjust the shutter speed using ◀ or ▶ on the multicontroller, or adjust the aperture using ▲ or ▼ on the multicontroller.
- When you select a fast shutter speed or shoot a subject in a dark place, set the flash to  (Red-Eye Reduction, Flash On) or  (Flash On) so that the LCD monitor does not darken and you can check the image before shooting.



- For the correlation between aperture value and shutter speed, see page 67.



Selecting an AF Frame

The AF frame indicates the area of the composition on which the camera focuses. You can set the AF frame in the following way.

<input type="checkbox"/> <input type="checkbox"/> <input type="checkbox"/>	Auto Selection (AiAF)	The camera automatically selects the AF frame to focus according to the shooting conditions.
<input type="checkbox"/> <input checked="" type="checkbox"/> <input type="checkbox"/> <input checked="" type="checkbox"/> <input type="checkbox"/> <input type="checkbox"/> <input type="checkbox"/> <input type="checkbox"/> <input type="checkbox"/>	Manual Selection	Manually select one of the three AF frames. This is convenient for focusing accurately on an off-center subject to obtain the composition you desire.

indicates the selected AF frame which appears green on the LCD monitor.

1 Press .

- The three frames appear on the LCD monitor.

2 Select the AF frame using ◀ or ▶ on the multicontroller.

- The selected frame appears green.

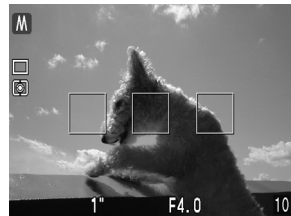







3 Press .

- You can immediately shoot the image using the selected AF frame by pressing the shutter button instead of pressing .

4 Shoot the image.



Shooting Modes and Selectable AF Frames

Shooting Mode	AF Frames
P Tv Av M	<input type="checkbox"/> <input checked="" type="checkbox"/> <input type="checkbox"/> <input checked="" type="checkbox"/> <input type="checkbox"/> <input type="checkbox"/> <input type="checkbox"/> <input type="checkbox"/> <input checked="" type="checkbox"/>
AUTO   	<input type="checkbox"/> <input checked="" type="checkbox"/> <input type="checkbox"/> <input type="checkbox"/> <input checked="" type="checkbox"/> <input type="checkbox"/> <input type="checkbox"/> <input checked="" type="checkbox"/> <input type="checkbox"/>
  	<input type="checkbox"/> <input checked="" type="checkbox"/> <input type="checkbox"/> <input type="checkbox"/> <input checked="" type="checkbox"/> <input type="checkbox"/> <input type="checkbox"/> <input checked="" type="checkbox"/> <input type="checkbox"/>

* In the macro modes, the AF frame always set to " ".

• The camera resumes the auto selection mode after you turn off the camera.



Selecting an AF Frame (continued)



- If any particular AF frame is selected, it is recommended that you use the LCD monitor to check the AF frame while shooting.
- When the Spot AE Point is selected as the light metering method, you can use the selected AF frame as the Spot AE Point (p. 82).
- For an explanation of the AF frame colors, please refer to page 34.
- If the shooting mode is changed, the AF frame may also change depending on the shooting mode. See the table below.

Initial Shooting Mode	Next Shooting Mode	AF frames after change
P Tv Av M 	AUTO	
P Tv Av M 	P Tv Av M	No change
P Tv Av M 	P Tv Av M	



- AiAF* has a wide range of measuring for accurate focusing. AiAF focuses on the object even if it is not exactly at the center area.

* "Ai" stands for "Artificial intelligence" and "AF" stands for "Auto Focus."

Adjusting the Exposure Compensation

Adjust the exposure compensation setting to avoid making the subject too dark when it is backlit or shot against a bright background.



- 1** Press the /WB// button once.
 - The  icon and exposure compensation bar will appear on the LCD monitor if it is on.



- 2** Select a setting using ◀ or ▶ on the multicontroller.
 - The settings can be adjusted in 1/3 steps in the range of -2EV to +2EV.

- 3** Press **SET**.
 - You can also take the picture with the set exposure compensation value by pressing the shutter button without pressing **SET**.
 - To cancel the exposure compensation, return the setting to 0 using ◀ or ▶ on the multicontroller.









- 4** Shoot the image.
 - If you pressed the shutter button at Step 3, the exposure compensation bar will reappear after the shot, allowing you to change the setting for the next shot.

-
-  This setting cannot be adjusted in the **AUTO** and **M** shooting modes. In  mode, it can only be adjusted for the first image.
 - The macro mode cannot be set while the exposure compensation bar appears on the LCD monitor.

-
-  The selected shooting mode will determine whether or not the exposure compensation setting is cancelled when the camera is turned off (p. 90).

WB Setting the White Balance

When the white balance mode is set to match the light source, the camera can reproduce colors more accurately. Set the white balance mode to a natural or artificial light setting according to the circumstances.

 AWB	Auto	Settings are automatically set by the camera
	Daylight	For recording outdoors on a bright day
	Cloudy	For recording under overcast, shady or twilight skies
	Tungsten	For recording under tungsten and bulb-type 3-wavelength fluorescent lighting
	Fluorescent	For recording under warm-white, cool-white or warm-white (3-wavelength) fluorescent lighting
	Fluorescent H	For recording under daylight fluorescent, or daylight fluorescent-type 3-wavelength fluorescent lighting
	Flash	For flash photography
	Custom	For setting a custom value with a white sheet of paper, etc., to obtain the optimal white balance for the conditions

1 Press the /WB// button twice.

- The balance setting menu appears on the LCD monitor.



2 Select a setting using ◀ or ▶ on the multicontroller.

- Please see the next page regarding the  custom setting.

3 Press **SET**.



- You can also take the picture in the set white balance mode by pressing the shutter button without pressing **SET**.

4 Shoot the image.

- If you pressed the shutter button at Step 3, the current white balance mode will reappear after the shot, allowing you to change the setting for the next shot.

.....



- This setting cannot be adjusted in the **AUTO** and  (Sepia and B/W) shooting modes. In  mode, it can only be adjusted for the first image.
- The metering mode (p. 82) cannot be changed and the macro mode cannot be set while the white balance setting menu appears on the LCD monitor.

.....





- The selected shooting mode will determine whether or not the white balance setting is cancelled when the camera is turned off (p. 90).



Setting a Custom White Balance

You can set a custom white balance to obtain the optimal setting for the shooting conditions by having the camera evaluate a subject such as a white piece of paper or cloth, or a photo-quality gray card.

- 1** Press the /WB// button twice.
 - The WB setting menu appears on the LCD monitor if it is on.

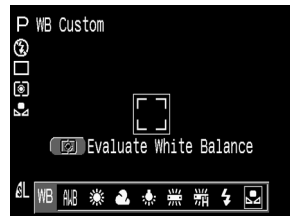
- 2** Select  using  or  on the multicontroller.



- 3** Aim the camera at the white paper or cloth, or gray card and press the  button.
 - Aim the camera so that the white paper or cloth, or gray card, completely fills the frame on the LCD monitor screen or the entire viewfinder before pressing the  button. When you press the  button, the camera reads the white balance data.

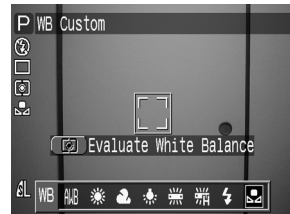



- 4** Press **SET**.
 - You can also take the picture with the white balance set to the selected value by pressing the shutter button without pressing **SET**.

- 5** Shoot the image.
 - If you pressed the shutter button at Step 4, the white balance mode will reappear after the shot, allowing you to change the setting for the next shot.

WB Setting the White Balance (continued)



- To set and use a custom white balance setting, it is advisable to select the **P** shooting mode and set the exposure compensation and flash exposure compensation to zero (± 0). The correct white balance may not be obtained when the exposure is incorrect (image is completely black or white).
- It is also advisable to use the LCD monitor to compose the shot and to zoom in to the maximum telephoto setting.
- Since the white balance data cannot be read in  mode, preset the white balance in another shooting mode first before selecting  mode.
- If the flash fires when setting a custom white balance with the flash set to red-eye reduction auto or auto, make sure you also use the flash when you go to shoot. The correct white balance cannot be obtained unless the flash is used consistently. To ensure consistency, set the flash to on or off as appropriate.
- The selected shooting mode will determine whether or not the custom white balance setting is cancelled when the camera is turned off.



Auto Exposure Bracketing (AEB Mode)

In this mode, the camera automatically changes the exposure within a set range to take three shots after you press the shutter button once. You can adjust AEB settings in 1/3EV steps within the range of -2EV to +2EV of the standard exposure setting. AEB settings can be combined with exposure compensation settings (p. 73) to extend the adjustment range. The images are shot in the following order: Standard exposure, underexposure and overexposure.

1 Press the /WB// button three times.

- The  icon and the exposure compensation bar appear on the LCD monitor.



2 Expand or contract the range using ◀ or ▶ on the multicontroller.

- Use ▶ to expand the range and ◀ to contract it.

3 Press **SET**.

- You can also take the picture with the set exposure compensation value by pressing the shutter button without pressing **SET**.
- To cancel the AEB setting, return the setting to 0 using ◀ or ▶ on the multicontroller.

4 Shoot the image.

- If you pressed the shutter button at Step 3, the  icon and the exposure compensation bar will reappear after the shot, allowing you to change the setting for the next shot.



- The AEB mode cannot be used for flash photography. If the flash fires, only one image gets recorded.
- The macro mode cannot be set while the exposure compensation bar appears on the LCD monitor.



- This function can only be selected in the **P**, **Tv** and **Av** shooting modes.
- The selected shooting mode will determine whether or not the AEB setting is cancelled when the camera is turned off.



Adjusting the Flash Output (Flash Exposure Compensation)

You can adjust the flash output for flash photography.

1 Press the button four times.

- The icon and the flash exposure compensation bar appears on the LCD monitor.

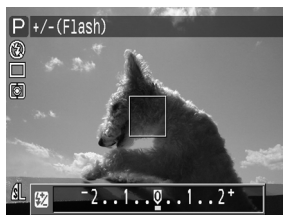

2 Expand or contract the range using or on the multicontroller.

- The flash exposure compensation can be adjusted in 1/3 steps within a range of -2EV to +2EV.

3 Press **SET**.

- You can also take the picture with the set flash exposure compensation value by pressing the shutter button without pressing **SET**.
- To cancel the setting, return the setting to using or on the multicontroller.

4 Shoot the image.

- If you pressed the shutter button at Step 3, the icon and the flash exposure compensation bar will reappear after the shot, allowing you to change the setting for the next shot.



- This setting cannot be adjusted in the **AUTO**, and **M** shooting modes. In mode, it can only be adjusted for the first image.
- The macro mode cannot be set while the flash exposure compensation bar appears on the LCD monitor.



- The selected shooting mode will determine whether or not the flash exposure compensation setting is cancelled when the camera is turned off (p. 90).



Locking the Exposure Setting (AE Lock)

You can set the exposure and focus separately. This is effective when the contrast is too strong between the subject and background or when a subject is backlit. For an explanation of how different combinations of light metering options and a selected AF frame affect where the AE lock is metered, see page 80.

1 Press the **DISPLAY** button to turn on the LCD monitor.

2 Focus on the subject on which you wish to lock the exposure setting.

- Press the shutter button halfway.

3 While pressing the shutter button halfway, press the  button.

- The exposure setting locks (AE Lock) and the * icon appears on the LCD monitor.
- Using any button, lever or switch other than pressing the shutter button halfway or using ◀, ▶, ▲ or ▼ on the multicontroller cancels the AE lock.



AE Lock Icon

4 Recompose the image and shoot.





Locking the Exposure Setting (AE Lock) (continued)



- The AE lock function cannot be used when the optical viewfinder is used to shoot.



- This function can only be selected in the **P**, **Tv** and **Av** shooting modes.



The automatically selected combinations of shutter speeds and aperture values can be freely changed without altering the exposure with the following procedures.

- 1 Turn the mode dial to **P**, **Tv** or **Av**.
- 2 Press the **DISPLAY** button to turn on the LCD monitor.
- 3 Focus on the subject on which you wish to lock the exposure.
- 4 Press the  button.
 - The exposure setting will lock and the ***** icon will appear in the display panel and LCD monitor.
- 5 Press **◀** or **▶** on the multicontroller until the desired shutter speed or aperture value is reached.
- 6 Recompose the image and shoot.
The setting will cancel after the shot is taken.







Exposure Metering Position for the AE/FE Lock According to Different Light Metering Options when an AF Frame is Selected (Creative Shooting Modes)

Light Metering Option	AF Frame Is Selected	
Evaluative Light Metering	AE/FE locks at the exposure metered within the selected AF frame	
Center-Weighted Averaging	AE/FE locks at the exposure metered in the center AF frame	
Spot AE Point	Center	AE/FE locks at the exposure metered in the spot AE point at the center
	AF Point	AE/FE locks at the exposure metered in the spot AE point corresponding to the selected AF frame



Locking the Flash Exposure Setting (FE Lock)

You can lock the flash exposure so that the exposure settings are correctly set for a particular portion of your subject. For an explanation of how different combinations of light metering options and a selected AF frame affect where the FE lock is metered, see page 80.

- 1** Press the **DISPLAY** button to turn on the LCD monitor.
- 2** Set the flash to fire (p. 47).
- 3** Focus on the subject on which you wish to lock the flash exposure setting.
 - Press the shutter button halfway.
- 4** While pressing the shutter button halfway, press the  button.
 - The flash exposure compensation setting locks (FE lock) and the  icon appears on the LCD monitor.
 - The flash will fire a pre-flash and lock the flash exposure to the required intensity to illuminate the subject. (Each time you press the  button, the flash exposure locks at the required intensity for that composition).
 - Using any button, lever or switch other than pressing the shutter button halfway or using , ,  or  on the multicontroller cancels the FE lock.

- 5** Recompose the image and shoot.
 - As the example to the right shows, a backlit subject can be shot at the correct exposure if the FE lock is set when the camera is aimed at a non-backlit portion of the subject.



• This function can only be selected in the **P**, **Tv** and **Av** shooting modes.



Switching between Light Metering Modes

Center-weighted averaging is the default light metering mode. This can be switched to spot light metering.

	Evaluative Light Metering	Appropriate for standard shooting conditions, including backlit scenes. The camera divides images into several zones for light metering. The camera evaluates the complex lighting conditions, such as the position of the subject, the brightness, the background, the direct light, and the backlighting, and adjusts the settings to the correct exposure for the main subject.
	Center-Weighted Averaging	Averages the exposure from the entire image, but places more weight on the subject at the center. Use this mode when the subject is backlit or surrounded by bright light.
	Center	Meters the area within the spot AE point frame at the center of the LCD monitor.
	AF Point	Meters the spot AF point corresponding to the selected AF frame.

1 Press the **DISPLAY** button to turn on the LCD monitor.

2 Press the button to select the metering mode.

- Each press of the button changes the metering mode as follows.

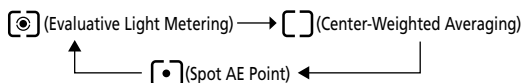

- The icon of the currently selected light metering mode appears on the LCD monitor.

If you have selected (Spot AE Point), go to step 3.

If you have selected (Evaluative Light Metering) or (Center-Weighted Averaging), go to step 5.



3 In the [(Rec.)] menu, select [Spot AE Point].

- See Selecting Menus and Settings (p. 38).

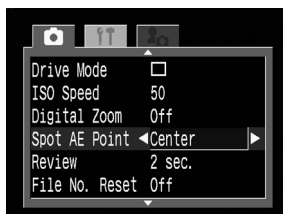

4 Select the [Center] or [AF Point] option, then press the **MENU** button.

- When [Spot AE Point] is set to [Center], the spot AE point frame appears at the center of the LCD monitor, and when [Spot AE Point] is set to [AF Point], it appears inside the selected AF frame.

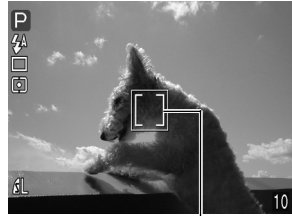

e.g. Center

Spot AE Point Frame

5 Shoot the image.

-
-  The light metering mode cannot be changed while the white balance setting menu appears on the LCD monitor.

-
-  This function can only be selected in the **P**, **Tv**, **Av** and **M** shooting modes.
 - The setting is cancelled when the camera power is turned off. However, the [Spot AE Point] option selected in the menu remains selected.

Shooting Problem Subjects for the Autofocus

The autofocus may not work well on the following types of subjects.

- Subjects with extremely low contrast to the surroundings
- Subjects mixing close and far objects
- Subjects with extremely bright objects at the center of the composition
- Subjects that are moving quickly

To shoot these subjects, first aim the camera at an object at a similar distance, lock the focus and recompose the image with the desired subject, or use the manual focus.



- When shooting through glass, get as close as possible to avoid reflections off the glass.

Shooting with Focus Lock

Focus Lock Method 1

- 1** Press the **DISPLAY** button to turn on the LCD monitor.
- 2** Aim the AF frame at an object at a similar distance to the subject you wish to shoot.
- 3** Press the shutter button halfway to lock the focus.
 - The AE setting will also lock when you do this. The exposure may occasionally be incorrect if the difference between the two items is too great. Use Method 2 or the AE lock procedure when this happens.
- 4** Keep it pressed while you recompose the image and press the shutter button all the way to shoot the image.

Focus Lock Method 2

1 Press the **DISPLAY** button to turn on the LCD monitor.

2 Press the shutter button halfway to lock the focus. Keep it pressed and press the **MF** button.

- The **MF** icon appears on the LCD monitor.
 - The focus setting will lock even if the shutter button and the **MF** button are released.
 - The manual focus setting will cancel if the **MF** button is pressed again.
-

3 Recompose the image and press the shutter button all the way to shoot the image.

.....
 • Focus lock cannot be used while the shooting mode is set to **AUTO**.

.....
 • Method 2 is convenient because you can let go of the shutter button to recompose the image.

Shooting Problem Subjects for the Autofocus (continued)

Shooting in Manual Focus Mode

The focus can be manually set.

1 Press the **DISPLAY** button to turn on the LCD monitor.

2 Press and hold the **MF** button, then use **▲** or **▼** on the multicontroller.

- The focus will lock and the **MF** icon and the MF indicator will appear on the LCD monitor. If a particular AF frame has been manually selected, the portion of the image in that frame will appear magnified.*

* Except in the **□**, **■** modes, when the digital zoom is activated or a TV is used as the display.

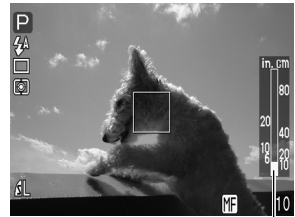

MF indicator

- The MF indicator shows approximate figures. Use them as a shooting guideline only.
- Adjust the focus using **▲** or **▼** on the multicontroller until the image appears focused on the LCD monitor.
- Pressing the **MF** button a second time cancels the manual focus mode.

3 Shoot the image.

- The indicator beside the viewfinder shines yellow when the shutter button is pressed halfway.



- This setting cannot be adjusted in **AUTO** shooting mode.
- You cannot change the AF frame setting while focusing manually. Cancel the manual focus mode, then change the AF frame setting. With the changed AF frame setting, you can resume the manual focus mode.



- You can use manual focus in the macro focal distance 10 to 80 cm (3.9 in. to 2.6 ft.) at maximum wide angle and 30 to 80 cm (11.8 in. to 2.6 ft.) at maximum telephoto. In this case, the fine scale is adopted.
- If the camera is protected by Digital Camera Waterproof Case WP-DC300 (optional), be sure to press and hold the **MF** button then use **◀** or **▶** on the multicontroller to display the MF indicator and adjust the focus.

Manually Setting Image Characteristics

The ISO speed, contrast, sharpness and saturation settings can be adjusted for shooting.

1 In the [RECALL] (Rec.) menu, select one of the above items.

- See Selecting Menus and Settings (p. 38).

2 Select a value for the item and press the **MENU** button.

ISO speed

- Switch speeds when you are shooting in dark areas or want to use a fast shutter speed.
- You can select from 50 (default setting), 100, 200, 400, 800 (only for PowerShot S30) and AUTO.
- When AUTO is selected, the camera automatically adjusts ISO between 50 and 100 only.
- Higher ISO speeds increase the image noise. To take clean images, use as low an ISO speed as possible.

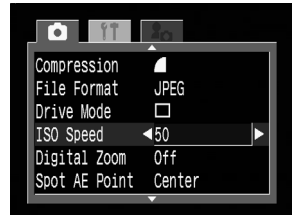

Contrast

- Select from - (Weak), 0 (Neutral) and + (Strong).
- This function allows you to adjust the degree of brightness.

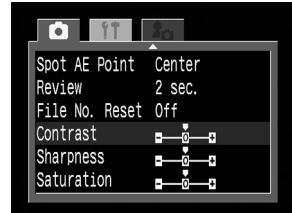

Sharpness

- Select from - (Weak), 0 (Neutral) and + (Strong).
- This function allows you to adjust how sharply outlines are defined.

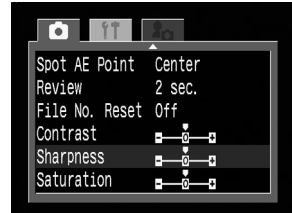

Saturation

- Select from - (Weak), 0 (Neutral) and + (Strong).
- This function allows you to adjust the color depth.

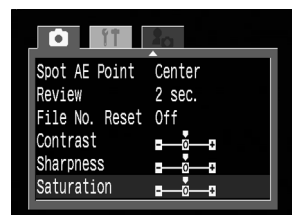

Manually Setting Image Characteristics (continued)

3 Shoot the image.



- These functions can only be selected in the **P**, **Tv**, **Av** and **M** shooting modes. In the **M** mode, however, the ISO speed cannot be set to [Auto].
- These settings are memorized even when the camera power is turned off.

Resetting the File Numbers

You can select the way file numbers are assigned.

On	The file numbers are reset to the start (100-0001) each time a new CF card is inserted. New images recorded on CF cards with existing files are assigned the next available number.
Off	The file number of the last image to be shot is memorized so that images recorded to a new CF card start from the next number.

1 In the [ (Rec.)] menu, select [File No. Reset].

- See Selecting Menus and Settings (p. 38).

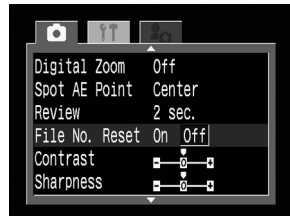

2 Select [On] or [Off] and press the **MENU** button.



- Setting the [File No. Reset] to [Off] is useful for avoiding file name duplication when images are downloaded to a computer.



About File Numbers

- Images are assigned file numbers from 0001 to 9900 and organized in folders usually containing up to 100 images. Folders are assigned numbers from 100 to 998.

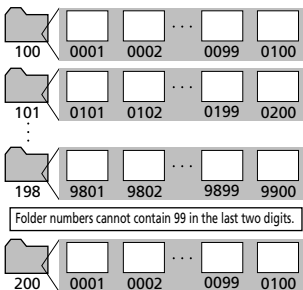

Since images shot in continuous mode or Stitch Assist mode are always saved in the same folder, some folders may contain 101 or more images.

Functions Available in Each Shooting Mode

This chart shows the functions available in each shooting mode.

																	Reference Page
Flash	Red-Eye Reduction, Auto	●*	●*	●	●*	●	●	●	●	●	●	●	●	●	●	●	p. 47
	Auto	●	●	●	●	●*	●	●*	●	●	●	●	●	●	●	●	
	Red-Eye Reduction, Flash On	—	●	●	●	●	●	●	●	●	●	●	●	●	●	●	
	On	—	●	●	●	●	●	●	●	▲	●	●	●	●	●	●	
	Off	●	●	●*	●	●	●*	●	●	▲	●*	●*	●*	●*	●*	●*	
Macro Mode		●	●	—	—	●	●	●	●	●	●	●	●	●	●	●	p. 57
Drive Mode	Single Shot	●*	●*	●*	●*	●*	●*	●*	●*	●*	●*	●*	●*	●*	●*	●*	—
	Normal Continuous Mode	—	●	●	●	●	●	●	●	—	—	●	●	●	●	●	p. 59
	High Speed Continuous Mode	—	●	●	●	●	●	●	●	—	—	●	●	●	●	●	p. 59
	Self-Timer (10 sec.)	●	●	●	●	●	●	●	●	●	●	●	●	●	●	●	p. 58
	Self-Timer (2 sec.)	●	●	●	●	●	●	●	●	●	●	●	●	●	●	●	p. 58
AF Frame	Auto	●*	●*	●*	●*	●*	●*	● ⁽¹⁾	● ⁽¹⁾	● ⁽¹⁾	—	—	—	—	—	—	p. 71
	Manual	● ⁽²⁾	● ⁽²⁾	● ⁽³⁾	● ⁽³⁾	● ⁽²⁾	● ⁽²⁾	—	—	—	—	—	—	—	—	—	p. 71
Exposure Compensation		—	●	●	●	●	●	●	●	▲	●	●	●	●	●	—	p. 73
White Balance WB		—	●	●	●	●	●	● ⁽⁴⁾	▲	●	●	●	●	●	●	—	p. 74
AEB Mode		—	—	—	—	—	—	—	—	—	—	●	●	●	—	—	p. 77
Flash Exposure Compensation		—	●	●	●	●	●	●	●	▲	—	●	●	●	—	—	p. 78
AE Lock/FE Lock *		—	—	—	—	—	—	—	—	—	—	●	●	●	—	—	p. 79, 81
Light Metering Method	Evaluative Metering	●	●	●	●	●	●	●	●	●	●	●*	●*	●*	●*	—	p. 82
	Center-Weighted Averaging	—	—	—	—	—	—	—	—	—	—	●	●	●	●	—	
	Spot Metering	—	—	—	—	—	—	—	—	—	—	●	●	●	●	—	
	Center	—	—	—	—	—	—	—	—	—	—	●*	●*	●*	●*	—	
AF Point	—	—	—	—	—	—	—	—	—	—	●	●	●	●	—		
Manual Focus MF		—	●	●	●	●	●	●	●	●	●	●	●	●	●	●	p. 86
Resolution	Large L	●*	●*	●*	●*	●*	●*	●*	●*	▲	—	●*	●*	●*	●*	—	p. 61
	Medium 1 M1	●	●	●	●	●	●	●	●	▲	—	●	●	●	●	—	
	Medium 2 M2	●	●	●	●	●	●	●	●	▲	—	●	●	●	●	—	
	Small S	●	●	●	●	●	●	●	●	▲	—	●	●	●	●	—	
	Movie	—	—	—	—	—	—	—	—	—	—	●*	—	—	—	—	
	Movie	—	—	—	—	—	—	—	—	—	—	●	—	—	—	—	
Compression	Superfine S	●	●	●	●	●	●	●	●	●	—	●	●	●	●	—	p. 61
	Fine	●*	●*	●*	●*	●*	●*	●*	●*	●*	—	●*	●*	●*	●*	—	
	Normal	●	●	●	●	●	●	●	●	●	—	●	●	●	●	—	
File Format	JPEG	●	●	●	●	●	●	●	●	—	—	●*	●*	●*	●*	—	p. 64
	RAW RAW	—	—	—	—	—	—	—	—	—	—	●	●	●	●	—	

										P	Tv	Av	M	Reference Page
ISO Speed	— ⁽⁵⁾	— ⁽⁵⁾	— ⁽⁵⁾	— ⁽⁵⁾	— ⁽⁵⁾	— ⁽⁵⁾	— ⁽⁵⁾	— ⁽⁵⁾	— ⁽⁵⁾	●	●	●	— ⁽⁶⁾	p. 87
Digital Zoom	●	●	●	●	●	●	●	—	—	●	●	●	●	p. 60
Contrast	—	—	—	—	—	—	—	—	—	●	●	●	●	p. 87
Sharpness	—	—	—	—	—	—	—	—	—	●	●	●	●	
Saturation	—	—	—	—	—	—	—	—	—	●	●	●	●	

* Default setting.

● Setting selection is possible.

▲ Setting can only be selected for the first image.

— Setting selection is not possible.

■ (Shaded Area) Setting remains in effect even when the camera is turned off.

The default for all of the settings changed by the menu and button operations can be restored all at once except for [Date/Time], [Language] and [Video System] (p. 141).

- (1) In Macro mode, the AF frame is set to the center.
- (2) The AF frame can only be set to the center. In Macro mode, the AF frame is also set to the center.
- (3) The AF frame can only be set to the center.
- (4) The sepia and B/W modes cannot be set.
- (5) The ISO speed is automatically set between the equivalent of 50 and 100.
- (6) [AUTO] cannot be selected.

Viewing Images Singly (Single Image Replay)

You can view the recorded images on the LCD monitor.

1

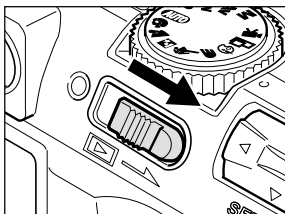

Slide the power/replay lever to the right.

- The last recorded image appears (Single Image Replay).

2

Move between images using ◀ or ▶ on the multicontroller.

- Use ◀ to move to the previous image and ▶ to move to the next. Holding ◀ or ▶ moves more rapidly between images, but the images will not appear as clearly.



- Press the **DISPLAY** button to show the data for the displayed image (p. 30).
- Press the  button to quickly delete the displayed image (p. 104).
- You can change the display language on the LCD monitor if you press and hold **SET** then press the **JUMP** button (p. 25). (This function cannot be used while Card Photo Printer CP-10 (optional) or Bubble Jet Printer with the direct print function is connected to the camera.)

Magnifying Images

In single image replay, the displayed image can be shown magnified by an approximate factor of 2.5 or 5 for PowerShot S30 and 3 or 6 for PowerShot S40.

1 Slide the power/replay lever to the right.

2 Slide the zoom lever toward .



Magnified approximately 3 times (PowerShot S40)
Approximate position

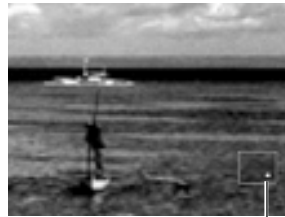



Magnified approximately 6 times (PowerShot S40)
Approximate position

- The display cycles to the next magnification mode each time you slide the zoom lever toward .
- You can move around the magnified image using ◀, ▶, ▲ or ▼ on the multicontroller.

Reducing the size of the enlarged image until it displays in its original size

1 Slide the zoom lever toward .

- The most magnified image is reduced to 2.5 times the original size for PowerShot S30 and 3 times the original size for PowerShot S40 by sliding the zoom lever toward . Sliding the zoom lever toward  again reduces the image to its original size.



- Movie frames and index replayed images cannot be magnified.
- If the camera is protected by Digital Camera Waterproof Case WP-DC300, you cannot move the magnified area using ▲ or ▼ on the multicontroller.



- You can magnify an image while it is displayed on the LCD monitor in Shooting mode immediately after the image is shot (p. 46).

Viewing Nine Images at a Time (Index Replay)

Up to nine images can be viewed at once in Index Replay.

1 Slide the power/replay lever to the right.

2 Press the  button.

- Nine images appear at once (Index Replay).

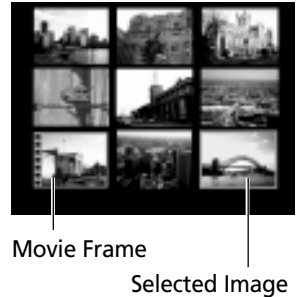

3 Change the image selection using **◀**, **▶**, **▲** or **▼** on the multicontroller.



← The **▲** operation in this row displays the previous set of nine images.

← The **▼** operation in this row displays the next set of nine images.

4 Press the  button.

- Index replay cancels and the display reverts to single image replay.

.....



• Press the **DISPLAY** button to show the data for the displayed image (p. 30).

JUMP Jumping Between Images

The display can be advanced or set back 9 images in either single image replay or index replay.

1 Press the **JUMP** button while in single replay (p. 92) or index replay (p. 94).

- The jump bar appears.

2 The displayed image(s) change.

Single Replay

- Jump 9 images behind or ahead using ◀ or ▶ on the multicontroller.

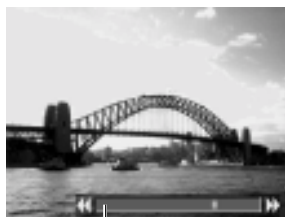

Jump Bar

Index Replay

- Jump to the previous or next set of nine images using ◀ or ▶ on the multicontroller.



Jump Bar

3 Press the **JUMP** button.

- The jump bar disappears and the jump mode cancels.



Viewing Movies

You can replay the images shot in  mode.

1 Slide the power/replay lever to the right.



- Movies cannot be viewed in index replay.

2 Display an image shot in mode using or on the multicontroller.

- A movie displays with the instruction    on it.





3 Press **SET**.

- The movie images and sound will play.
- You can adjust the volume using  or  on the multicontroller.
- When a movie has finished playing, it will display the last frame. If **SET** is pressed in this state, the movie will start playing from the first frame.

Pausing and Resuming Play

- Press **SET** to pause the movie. Press it again to resume.

Fast Forwarding / Rewinding

- Use  or  on the multicontroller to stop the movie and display the previous or next image or movie.

.....



- You may experience frame dropping and audio breakup when replaying a movie on a computer with insufficient system resources.

.....



- The volume at which movies replay can also be adjusted in the Play menu (p. 137).
- Please adjust the audio sound level on the TV when viewing movie files on a TV.

Rotating Images in the Display

Images can be rotated 90° and 270° clockwise on the LCD monitor.

Original



90°



270°

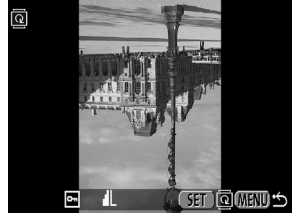

1 In the [▶] (Play) menu, select [Rotate] and press **SET**.

- See Selecting Menus and Settings (p. 38).

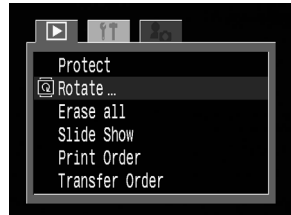

2 Select an image you want to rotate using ◀ or ▶ on the multicontroller and press **SET**.

- The image cycles to the next orientation (90° → 270° → original) each time **SET** is pressed.



3 Press the **MENU** button.

- The Play menu appears again. Press the **MENU** button again to close the menu.



- Movie images cannot be rotated.



- When images are downloaded to a computer, the orientation of images rotated by the camera will depend upon the software used to download the images.





- Images can be magnified when rotated (p. 93).

Attaching Sound Annotations to Images

In replay mode (including single replay, index replay, magnifying replay and the replay immediately after shooting in Shooting mode) you can attach sound annotations (up to 60 seconds) to an image. The sound data is saved in WAVE format.





- 1 Press the  button while replaying images.
 - The A / V panel appears.



- 2 Select  using  or  on the multicontroller, then press **SET**.
 - The recording starts and the elapsed time is displayed. Speak towards the microphone of the camera.
 - To stop recording, press **SET**. To restart recording, press **SET** again.
 - You can add as many sound annotations as you like until their total time reaches 60 seconds.



Playing back the Sound Annotations

Select  in step 2 above. Images with sound annotations are displayed with the  mark. To start playback, press **SET**. To stop playback, press **SET** again. You can adjust the volume using  or  on the multicontroller.

Erasing the Sound Annotations

Select  in step 2 above.



- You cannot attach sound annotation to movies.
- If there is no space for recording on the CF card, the message "CF card full" appears and you cannot continue recording.
- You cannot attach sound annotations to an image if it already has any incompatible sound file. Such an image displayed with the  mark and the message "Unidentified sound file" appears.



- The volume can be adjusted in the Play menu (p. 137).

Automated Playback (Slide Show)

Starting a Slide Show

All images, or a selection of images, can be displayed one-by-one in an automated slide show.

All Images	Plays all the images on the CF card in order
Slide Show 1 - 3	Plays the images selected for each show in order (p. 100)

1 In the [▶] (Play) menu, select [Slide Show] and press **SET**.

- See Selecting Menus and Settings (p. 38).
- The slide show menu appears.

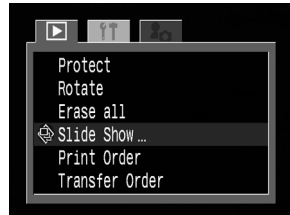

2 Select [Program] using ▲ or ▼ on the multicontroller. Then select between [All Images] or one of [Show 1]-[Show 3] using ◀ or ▶ on the multicontroller.

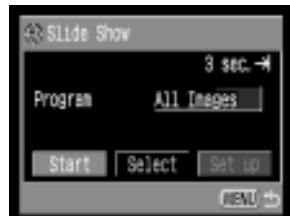

3 Select [Start] using ▲ or ▼ on the multicontroller and press **SET**.

- The slide show will start and automatically stop when the show is done.

Pausing and Resuming a Slide Show

- Press **SET** to pause the show. Press it again to resume.

Fast Forward / Rewinding a Slide Show

- Use ◀ or ▶ on the multicontroller to move to the previous or next image.

Stopping a Slide Show

- Press the **MENU** button during a slide show to stop it and display the slide show menu.

4 Press the **MENU** button.

- The slide show menu appears again. Press the **MENU** button again to close the menu.



- Movie images play for the length of time that they were recorded regardless of the time set in the slide show settings.
- The power save function is disabled while a slide show plays on the camera (p. 28).

Automated Playback (Slide Show) (continued)

Selecting Images for Slide Shows

You can mark images for inclusion in slide shows 1-3. Up to 100 images may be marked per slide show. Images display in the order of their selection.

1 Display the slide show menu (p. 99).

2 Select [Program] using **▲** on the multicontroller. Then select [Show 1], [Show 2] or [Show 3] using **◀** or **▶** on the multicontroller.

- A bright green bar will appear beside a show already containing images.



3 Choose [Select] using **▼**, and **◀** or **▶** on the multicontroller and press **SET**.

4 Mark images to include in the show.

Single Replay

- Move between images using **◀** or **▶** on the multicontroller and mark or remove marks from images using **▲** or **▼** on the multicontroller.
- The selection number and a bright green bar appear at the top of marked images.



Index Replay

- Press the **☐** button to switch to index replay (3 images).
- Select an image using **◀** or **▶** on the multicontroller and mark or remove marks from images using **▲** or **▼** on the multicontroller.
- The selection number and a bright green bar appear at the bottom of marked images.
- You can deselect all the images in a show by pressing **SET**, selecting [OK] using **◀** or **▶** on the multicontroller and pressing **SET** again.



-
- 5** Press the **MENU** button.
- The image selection screen will close.

Adjusting the Play Time and Repeat Settings

You can change the play time for all the images in a show and have the show repeat itself continuously.

Play Time	Sets the duration that each image in a slide show is displayed. The options are any one of 3-10 seconds, 15 seconds, 30 seconds and Manual.
Repeat	Sets whether the slide show stops when all the slides have been displayed or continues to display until stopped.

-
- 1** Display the slide show menu.
-
- 2** Select [Set up] using ◀ or ▶ on the multicontroller and press **SET**.
-
- 3** Select [Play Time] or [Repeat] using ▲ or ▼ on the multicontroller.

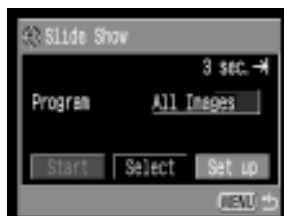

-
- 4** Select a setting using ◀ or ▶ on the multicontroller.
- Play Time**

- Select a play time.

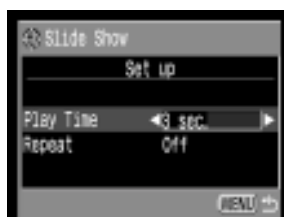

Repeat

- Select [On] or [Off].



Automated Playback (Slide Show) (continued)

5 Press the **MENU** button.

- The set up menu closes.



- The display interval may vary somewhat for some images.
- Slide shows can be easily edited on a computer with the supplied software. See the Software Starter Guide.

Protecting Images



You can protect important images from accidental erasure.

1 In the [ (Play)] menu, select [Protect] and press **SET**.

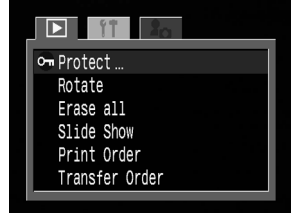
- See Selecting Menus and Settings (p. 38).



2 Select an image you want to protect using ◀ or ▶ on the multicontroller and press **SET**.

- The  icon appears on protected images.
- To remove the protection, press **SET** again (in protection mode).
- You can make the selection of images easier by toggling between single replay and Index replay with the  button.



3 Press the **MENU** button.

- The protect window closes.



- Please note that formatting (initializing) a CF card erases all data, including protected images (p. 106) and other file types. Please check the contents of a CF card before formatting it.

Erasing Images Singly



- Please note that erased images cannot be recovered. Exercise caution before erasing a file.

1

Set the camera to the replay mode (p. 29).

2

Select the image you wish to erase using ◀ or ▶ on the multicontroller and press the  button.

3

Select [Erase] using ◀ or ▶ on the multicontroller and press **SET**.

- To cancel instead of erasing, select [Cancel] and press **SET**.



- Protected images cannot be erased with the erase function (p. 103).

Erasing All Images



- Please note that erased images cannot be recovered. Exercise caution before erasing a file.

1 In the [▶] (Play) menu, select [Erase all] and press **SET**.

- See Selecting Menus and Settings (p. 38).

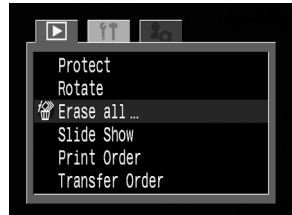

2 Select [OK] using ◀ or ▶ on the multicontroller and press **SET**.

- To cancel instead of erasing, select [Cancel] and press **SET**.



- Protected images cannot be erased with the erase function (p. 103).

Formatting a CF Card

You should format a new CF card or one from which you wish to erase all images and other data.



- Please note that formatting (initializing) a CF card erases all data, including protected images and other file types. Please check the contents of the CF card before formatting it.

1

In the **[F1 (Set up)]** menu, select **[Format]** and press **SET**.

- See Selecting Menus and Settings (p. 38).



2

Select **[OK]** using **◀** or **▶** on the multicontroller and press **SET**.

- To cancel formatting instead, select **[Cancel]** and press **SET**.



- If the camera does not work properly, the inserted CF card may be malfunctioning. Formatting the CF card may solve the problem.
- When a non-Canon brand CF card is malfunctioning, reformatting it may solve the problem.
- CF cards formatted in another camera, computer or peripheral device may not operate correctly. When that happens, reformat the CF card with this camera.

Print Settings (DPOF Print Settings)

Images on a CF card can be individually selected for printing in a specified number of copies. You can also select the print type and whether or not to print the date and file number. These settings are compatible with the Digital Print Order Format (DPOF) standards so that images can be printed on DPOF-compliant digital printers or at participating photo labs.



- The  mark appears on images that have had print marks set by another DPOF-compliant camera. These settings will be overwritten by any print marks set by your camera.
- Print settings cannot be set for movie images or RAW images.
- The output of some digital printers or photo lab services may not reflect the specified print settings.



- After you have set the DPOF settings, you can connect Card Photo Printer CP-10 (optional) or Bubble Jet Printer with the direct print function (optional) and print directly from the camera (p. 112, 121).

Selecting Images for Printing



There are two ways to select images.

- Singly
- All images on a CF card (the number of copies is set to one per image)

1 In the [ (Play)] menu, select [Print Order] and press **SET**.

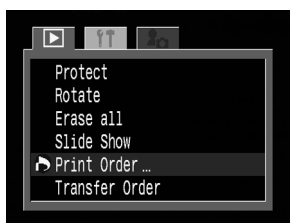
- See Selecting Menus and Settings (p. 38).
- The Print Order menu appears.



2 Select [Order] using  or  on the multicontroller and press **SET**.



Selecting Images for Printing (continued)

3 Select images for printing.

Single Images

- When the print type (p. 99) is set to [Standard] or [Both], select an image using ◀ or ▶ on the multicontroller. You can set the number of copies (up to 99) to be printed using ▲ or ▼ on the multicontroller.
- When the print type (p. 99) is set to [Index], select an image using ◀ or ▶ on the multicontroller and mark or remove marks from images using ▲ or ▼ on the multicontroller.
- You can use the same procedures to select images in index replay (3 images). Press the  button to switch between single replay and index replay.

All the Images on a CF Card

- Press the  button to switch to index replay (three images).
- You can set one copy of each image to print by pressing **SET**, then selecting [Mark All] using ▲ or ▼ on the multicontroller, and pressing **SET** again.
- When the print type is set to [Standard] or [Both], the setting for the number of print copies can be changed for each image. When [Index] is selected, the print settings can be deleted. For the instructions on changing settings, please reread Step 3 from the beginning.
- You can cancel all the settings by selecting [Clear all].



4 Press the **MENU** button.

- The selection mode will turn off and the Print Order menu will reappear.



- Images are printed in order from oldest to newest by the shooting date.
- A maximum of 998 images can be marked per CF card.
- When [Print Type] is set to [Both], the number of copies can be set. When it is set to [Index], the number of copies cannot be set (only one copy will be printed).
- Print settings can also be assigned to images with the supplied software programs on a computer.

Setting the Print Style

The following print settings can be selected.

Print Type	Standard	Prints one image per page
	Index	Prints the selected images together at a reduced size in an index format
	Both	Prints the images in both the standard and index formats
Date		Adds the date to the print
File No.		Adds the file number to the print

1 Display the Print Order menu (p. 107).

2 Select [Set up] using ◀ or ▶ on the multicontroller and press **SET**.

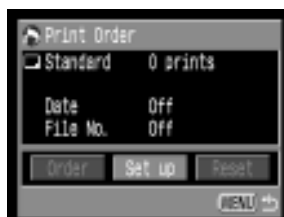

3 Select [Print Type], [Date] or [File No.] using ▲ or ▼ on the multicontroller.

4 Select a setting using ◀ or ▶ on the multicontroller.

Print Type

- Select [Standard], [Index] or [Both].

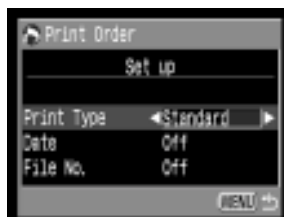

Date

- Select [On] or [Off].

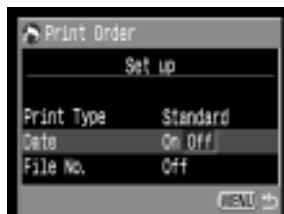

Setting the Print Style (continued)

File No.

- Select [On] or [Off].

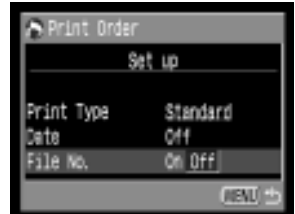

5 Press the **MENU** button.

- The set up menu will close and the Print Order menu will reappear.

.....



- When [Print Type] is set to [index], the [Date] and [File No.] cannot be set to [On].
- If [Print Type] is set to [Both], both [Date] and [File No.] can be set to [On], however, only the file number is printed for the index print.

.....



- The date prints as the date and time in the format specified in the Set Date/Time menu (p. 24).

Resetting the Print Settings

The print settings can all be removed at once. The print type is reset to [Standard] and the date and file number options are set to [Off].

1 Display the Print Order menu (p. 107).

2 Select [Reset] using ◀ or ▶ on the multicontroller and press **SET**.



3 Select [OK] using ◀ or ▶ on the multicontroller and press **SET**.

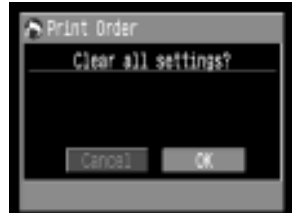

Printing with Card Photo Printer CP-10 (Optional)

Card Photo Printer CP-10, sold separately, can be connected to the camera and used to print images very easily directly from the camera. It can also be used with the DPOF print settings.

Connecting Card Photo Printer CP-10 to the Camera

Two direct interface cables are supplied with the printer. Use the cable (DIF-100) that has a ↔ Symbol on the connector to connect to this camera.



- You are recommended to use a household power supply to power the camera when it is connected to the printer. If you are using a battery pack, ensure that it is fully charged.

1 Turn off the camera (p. 27, 29).

2

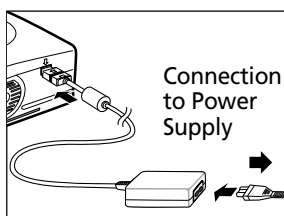

Connection
to Power
Supply

Attach the power cable to the printer and plug the other end into power supply.

3

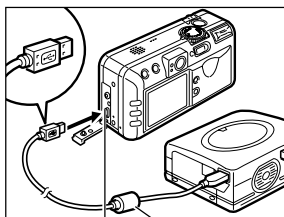

DIGITAL Terminal
Direct Interface
Cable DIF-100

Connect the camera and printer using the direct interface cable.

- When you insert the cable, make sure the ↔ mark of the cable faces the rear of the camera (monitor side).

4 Slide the power/replay lever to the right to turn on the camera.

-  appears on the camera LCD monitor and the power/mode indicator is lit in green when the printer is properly connected to the camera.



- When you detach the cable from the camera, hold the plug and do not pull the cable.



- Please see the Card Photo Printer CP-10 manual for instructions on loading paper and installing ink cartridges.
- The following operations cannot be conducted while the printer is connected.
 - Replaying movies
 - Setting the language using **SET** and the **JUMP** button combination.
- When the printer is disconnected, the  symbol will disappear from the LCD monitor and the camera will revert to standard replay mode.

Printing

An image can be printed when displayed in single replay or selected in index replay.

1 Choose an image using ◀ or ▶ on the multicontroller and press **SET**.

2 Set the number of prints, the print style and cropping settings as required.

- Selecting the number of copies (p. 115)
- Setting the Print Style (p. 115)
- Trimming (Printing a Portion of an image) (p. 117)

3 Choose [Print] using ▲, ▼, ◀ or ▶ on the multicontroller and press **SET**.

- You can also select [Print] by pressing the **JUMP** button.
- The image will start to print and, when it is completely finished, the display will revert to standard replay mode.



.....

- You cannot print movies or images recorded in the RAW format.

.....

Cancel Printing

- To cancel printing between images printed, press **SET**. A confirmation dialog appears. Select [OK] using ◀ or ▶ on the multicontroller and press **SET**.
- A print in progress cannot be stopped. Wait until the current image is printed and then cancel before the next one starts. The display will revert to standard replay mode.

Printing Errors

- An error message appears if an error occurs for some reason during the printing process (p. 149). Select [Stop] or [Resume] using ◀ or ▶ on the multicontroller and press **SET**.
- The [Resume] option may not appear with some error messages. Select the [Stop] option in that case.

Selecting the Number of Copies

1 In Replaying mode, press **SET** and select the [Copies] option using **▲** or **▼** on the multicontroller.

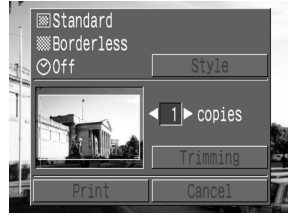

2 Specify the desired number of copies using **◀** or **▶** on the multicontroller.

- You can specify from 1 to 99 prints.

Setting the Print Style

You can select from among the following print styles.

Image	Standard	Prints one image per page.
	Multiple	Prints eight copies of the same image on one page.
Borders	Borderless	Prints right to the edges of the page.
	Bordered	Prints with a border.
Date		Prints the image's creation date.

1 In the print setting menu, choose [Style] using **▲** or **▼** on the multicontroller and press **SET** again.



Printing (continued)

- 2 Choose [Image], [Borders] or [Date] using ▲ or ▼ on the multicontroller.



- 3 Set the selection using ◀ or ▶ on the multicontroller.

Image



Choose [Standard] or [Multiple].

Borders

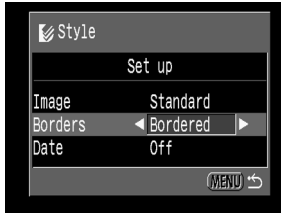

Choose [Borderless] or [Bordered].

Date



Choose [On] or [Off].

- 4 Press the **MENU** button.

- If [Borderless] or [Multiple] is selected as the print style, the center portion of the recorded image (the image displayed on the LCD monitor) is printed at an enlarged size. As a result, the image's top, bottom and sides may be cropped slightly. If you have not specified a trimming setting, a frame will appear around the area of the image that will be printed, allowing you to check the portion that will be cropped.



Print Area Frame



- The date and borders settings cannot be selected when the [multiple] option is selected. (The image will be printed with the Date set to [Off] and the Borders set to [Borderless].)
- With the [Bordered] option, the border is printed in practically the same space as the recorded image.

Trimming (Printing a Portion of an Image)

You can specify which portion for an image gets printed.



Prior to Trimming

Please set the Print Style (Image, Borders and Date) first before setting the trimming settings (p. 115).

1 In Replaying mode, press **SET** and choose [Trimming] using **▲** or **▼** on the multicontroller and press **SET** again.

- The trimming frame will appear at the center of the image. If a trimming setting has already been selected for the image, the frame will appear around the previously selected portion.



2 Trim the Image.

Changing the Size of the Trimming Frame

- Move the zoom lever toward **Q** or **Q**.
- The trimming frame can be changed to a minimum selection of approximately half the displayed image or a maximum selection that is virtually the same size as the image.
- You can cancel the trimming setting by moving the zoom lever toward **Q** again when the trimming frame is already set to the maximum size.
- If the image is magnified while in the trimming mode, it will print out more coarsely the greater the degree of magnification. The trimming frame will change to red.

Setting the Portion of the Trimming Frame

- Move the trimming frame using **▲**, **▼**, **◀** or **▶** on the multicontroller.

Rotating the Trimming Frame

- You can rotate the trimming frame by pressing the **DISPLAY** button.



Printing (continued)

- 3** Press the **MENU** button to close the setting menu.



Trimming Frame



- The trimming setting only applies to one image.
- The trimming setting is cancelled with the following operations.
 - When you set the trimming settings for another image.
 - When you close the Print mode (when you turn the camera power off, change the camera mode, or detach the DIF-100 direct interface cable).
 - When you try to expand the trimming frame beyond its maximum size.



- The selected Image Settings and Border setting determine the shape of the trimming frame.
- Please use the LCD monitor to set the trimming settings. The trimming frame may not display correctly on a TV monitor.

Printing with DPOF Print Settings on Card Photo Printer CP-10

You can use the DPOF print settings to print with Card Photo Printer CP-10 (optional).

- 1** In the [▶] (Play) menu, select [Print Order] and press **SET**.
 - See Selecting Menus and Settings (p. 38).
 - The Print Order menu appears.

- 2** Select [Print] using ▲, ▼, ◀ or ▶ on the multicontroller and press **SET**.

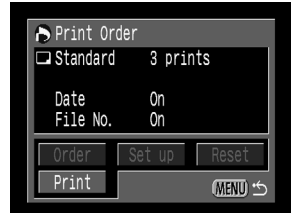

- 3** Set the print style settings as required.
 - See Setting the Print Settings (p. 115).
 - A print style cannot be set if the print type is set to [Index] in the DPOF print setting.



- 4** Select [OK] using ▲, ▼, ◀ or ▶ on the multicontroller and press **SET**.
 - The image will start to print and, when it is completely finished, the display will revert to the standard replay mode.

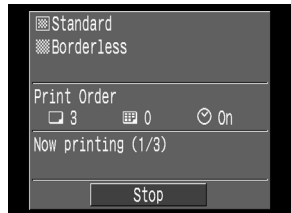

Printing with DPOF Print Settings on Card Photo Printer CP-10 (continued)



- To print the date, set the [Date] setting in the print order menu in Step 2 on the previous page to [On]. You cannot set the date to print with the [Style] menu in Step 3 on the previous page. If the print type is set to [Index], the date will not print even if the [Date] setting is set to [On] in Step 2.
- The file number will not print.



- When the Print Type is set to [Index], 20 images are printed on one page.

Cancel Printing

- To cancel printing between images, press **SET**. A confirmation dialog appears. Select [OK] using ◀ or ▶ on the multicontroller and press **SET**.
- A print in progress cannot be stopped. Wait until the current image is printed and then cancel before the next one starts. The display will revert to standard replay mode.

Restarting Printing

- In the Print Order menu, select [Resume] using ◀ or ▶ on the multicontroller and press **SET**. The remaining images can be printed.
- Printing cannot be restarted under the following circumstances.
 - If the print settings have been changed before restarting.
 - If the image for which the print settings were set has been deleted before restarting.
 - If there was very little free space on the CF card when the printing was cancelled.

If these circumstances apply, you can select [OK] in the Print Order menu and reprint starting from the first image. If printing was cancelled because the camera battery became discharged, you are recommended to power the camera with a household power source. If you must use a battery pack, ensure that it is fully charged for printing. After replacing the spent battery pack, turn the camera power on again.

Printing Errors

- An error message appears if an error occurs for some reason during the printing process (p. 149). Choose [Stop] or [Resume] using ◀ or ▶ on the multicontroller and press **SET**.
- The [Resume] option may not appear with some error messages. Select the [Stop] option in that case.

Printing with Bubble Jet Printer (Optional)

Bubble Jet Printer* with the direct print function, sold separately, can be connected to the camera and used to print images very easily directly from the camera. It can also be used with the DPOF print settings.

* Not sold in some regions

To find out if your Bubble Jet Printer supports the direct print function, or for general information about Bubble Jet Printers, please also refer to the Quick Start Guide supplied with your Bubble Jet Printer.

Connecting Bubble Jet Printer to the Camera

Use the Bubble Jet Printer - digital camera connection cable supplied with your Bubble Jet Printer.

Be sure to turn off the camera before connecting to Bubble Jet Printer.



- You are recommended to use a household power supply to power the camera when it is connected to the printer. If you are using a battery pack, ensure that it is fully charged. The printing may stop if the camera battery is discharged even if it is not complete; therefore, early replacement of the low battery with a fully charged one is recommended.

1

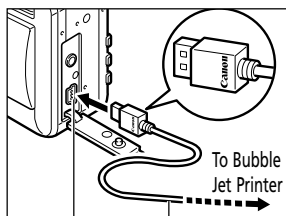

DIGITAL Terminal Bubble Jet Printer - digital camera connection cable

Connect the camera and printer using the cable.

- When you insert the cable, make sure the "Canon" logo on the cable faces the front of the camera (lens side).

2

Slide the power/replay lever to the right to turn on the camera.

-  appears on the camera LCD monitor and the power/mode indicator is lit green when the printer is properly connected to the camera.



Connecting Bubble Jet Printer to the Camera (continued)



- When you detach the cable from the camera, hold the plug and do not pull by the cable.



- Please see the Bubble Jet Printer Quick Start Guide manual for instructions to install paper and ink cartridges.
- The following operations cannot be performed while the printer is connected.
 - Replaying movies
 - Setting the language using the **SET** and the **JUMP** button combination.
- When the printer is disconnected, the  symbol will disappear from the LCD monitor and the camera will revert to standard replay mode.

Printing

An image can be printed when displayed in single replay or selected in index replay.

1 Choose an image using ◀ or ▶ on the multicontroller and press **SET**.

2 Set the number of prints, the print style and cropping settings as required.

- Selecting the number of copies (p. 124)
- Setting the Print Style (p. 124)
- Trimming (Printing a Portion of an image) (p. 126)

3 Choose [Print] using ◀ or ▶ on the multicontroller and press **SET**.

- You can also select [Print] by pressing the **JUMP** button.
- The image starts printing and, when it is completely finished, the display reverts to standard replay mode.



-
- You cannot print movies or images recorded in the RAW format.
-

Cancel Printing

- To cancel printing between images, press **SET**. A confirmation dialog appears. Select [OK] using ◀ or ▶ on the multicontroller and press **SET**. The printing stops even if it is incomplete and the paper is fed through.
- A print in progress cannot be stopped. Wait until the current image is printed and then cancel before the next one starts. The display reverts to standard replay mode.

Printing Errors

- An error message will appear if an error occurs for some reason during the printing process (p. 150). The printing resumes automatically after you correct the error. If the error persists, press **SET** and stop printing.
- The [Continue] and [Stop] options may appear with some error messages.
- The error number is displayed on the operation panel of Bubble Jet Printer. Please refer to the Bubble Jet Printer Quick Start Guide for the remedies corresponding to the error numbers.

Printing (continued)

Selecting the Number of Copies

- 1 In Replaying mode, press **SET** and select the [Copies] option using **▲** or **▼** on the multicontroller.





- 2 Specify the desired number of copies using **◀** or **▶** on the multicontroller.

- You can specify from 1 to 99 prints.

Setting the Print Style

You can select from among the following print styles.

 Paper		Select the paper size from the following. [Card #1], [Card #2], [Card #3], [LTR] or [A4] For the usable paper type, please refer to the Bubble Jet Printer User Guide.
 Borders	Borderless	Prints right to the edges of the page.
	Bordered	Prints with a border.
 Date		Prints the image's creation date.

- 1 In the print setting menu, choose [Style] using **▲** or **▼** on the multicontroller and press **SET**.



2 Choose [Paper], [Borders] or [Date] using ▲ or ▼ on the multicontroller.

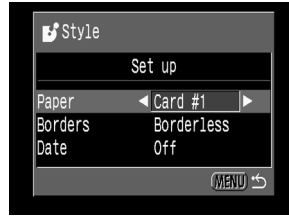

3 Set the selection using ◀ or ▶ on the multicontroller.

P Paper

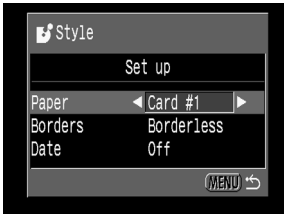

Choose [Card #1], [Card #2], [Card #3], [LTR] or [A4].

B Borders

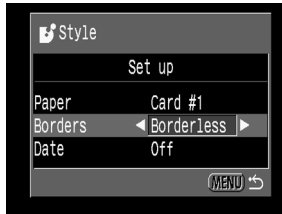

Choose [Borderless] or [Bordered].

D Date

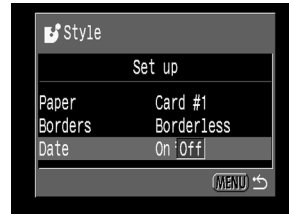

Choose [On] or [Off].

4 Press the **MENU** button.

- The setting is complete and the Print Order menu resumes.
- If [Borderless] is selected as the print style, the center portion of the recorded image (the image displayed on the LCD monitor) is printed at an enlarged size. As a result, the image's top, bottom and sides may be cropped slightly. If you have not specified a trimming setting, a frame will appear around the area of the image that will be printed, allowing you to check the portion that will be cropped.



Print Area Frame



- If you use the DPOF print settings for printing, **D** cannot be set. The date is printed according to the DPOF print setting.
- With the [Bordered] option, the image area remains relatively unchanged from the recorded image when it is printed.

Printing (continued)

Trimming (Printing a Portion of an Image)

You can specify which portion of an image gets printed.



Prior to Trimming

Please set the Print Style (Paper, Borders and Date) first before setting the trimming settings (p. 124).

1 In Replaying mode, press **SET** and choose [Trimming] using **▲** or **▼** on the multicontroller and press **SET** again.

- The trimming frame appears at the center of the image. If a trimming setting has already been selected for the image, the frame will appear around the previously selected portion.



2 Trim the Image.

Changing the Size of the Trimming Frame

- Move the zoom lever toward **🔍** or **🔍**.
- The trimming frame can be changed to a minimum selection of approximately half the displayed image or a maximum selection that is virtually the same size as the image.
- You can cancel the trimming setting by moving the zoom lever toward **🔍** again when the trimming frame is already set to the maximum size.



Setting the Portion of the Trimming Frame

- Move the trimming frame using **▲**, **▼**, **◀** or **▶** on the multicontroller.

Rotating the Trimming Frame

- You can rotate the trimming frame by pressing the **DISPLAY** button.

3 Press the **MENU** button to close the setting menu.



Trimming Frame



- The trimming setting only applies to one image.
- The trimming setting is cancelled with the following operations.
 - When you set the trimming settings for another image.
 - When you close the Print mode (when you turn the camera power off, change the camera mode, or detach the cable).
 - When you try to expand the trimming frame beyond its maximum size.



- The selected Paper Settings and Border setting determine the shape of the trimming frame.
- Please use the LCD monitor to set the trimming settings. The trimming frame may not display correctly on a TV monitor.

Printing with DPOF Print Settings on Bubble Jet Printer

You can use the DPOF print settings to print using Bubble Jet Printer with the direct print function (optional).

1 In the [ (Play)] menu, select [Print Order] and press **SET**.

- See Selecting Menus and Settings (p. 38).
- The Print Order menu appears.

2 Select [Print] using **▲**, **▼**, **◀** or **▶** on the multicontroller and press **SET**.



3 Set the print style settings as required.

- See Setting the Print Settings (p. 124).



4 Press **SET**.

- The image starts printing and, when it is completely finished, the display will revert to the standard replay mode.





- To print the date, set the DPOF [Date] setting to [On]. The date will not print with the Print Style date setting under these circumstances (p. 109). If the print type is set to [Index], the date will not print even if the [Date] setting is set to [On] in Step 2.
- The file number will not print.



Cancel Printing

- To cancel printing between images printed, press **SET**. A confirmation dialog appears. Select [OK] using ◀ or ▶ on the multicontroller and press **SET**. The printing stops even if it is incomplete and the paper is fed through.

Restarting Printing

- In the Print Order menu, select [Resume] using ◀ or ▶ on the multicontroller and press **SET**. The remaining images can be printed.
- Printing cannot be restarted under the following circumstances.
 - If the print settings have been changed before restarting.
 - If the image for which the print settings were set has been deleted before restarting.
 - If there was very little free space on the CF card when the printing was cancelled.

If these circumstances apply, you can select [OK] in the Print Order menu and reprint starting from the first image. If printing was cancelled because the camera battery became discharged, you are recommended to power the camera with a household power source. If you must use a battery pack, ensure that it is fully charged for printing. After replacing the spent battery pack, turn the camera power on again.

Printing Errors

- An error message appears if an error occurs for some reason during the printing process (p. 150). The printing resumes automatically after you correct the error. If the error persists, press **SET** and stop printing.
- The [Continue] and [Stop] options may appear with some error messages.
- The error number is displayed on the operation panel of Bubble Jet Printer. Please refer to the Bubble Jet Printer Quick Start Guide for the remedies corresponding to the error numbers.

Image Transfer Settings (DPOF Transfer Order)

Using the camera, you can make marks on images you wish to transfer and attach to e-mails. (Please use the supplied software for actually transferring images.) These settings are compatible with the Digital Print Order Format (DPOF) standards.



- The  mark will display on images that have had transfer marks set by another DPOF-compliant camera. These settings will be overwritten by any marks set by your camera.

Selecting Images for Transferring



There are two ways to select images.

- Singly
- All images on a CF card

1 In the [ (Play)] menu, select [Transfer Order] and press **SET**.

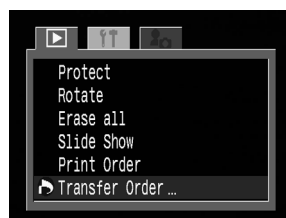
- See Selecting Menus and Settings (p. 38).
- The Transfer Order menu appears.



2 Select [Order] using  or  on the multicontroller and press **SET**.



3 Select images for transferring.

Single Images

- Select an image using ◀ or ▶ on the multicontroller and mark or remove marks from images using ▲ or ▼ on the multicontroller.
- You can use the same procedures to select images in index replay (3 images). Press the  button to switch between single replay and index replay.



All the Images on a CF Card

- Press the  button to switch to index replay (three images). Then press **SET**, and select [Mark All] using ▲ or ▼ on the multicontroller and press **SET** again. (If you select [Clear All] instead of [Mark All], you can remove marks from all the images.)
- You can mark or remove a mark from each image after marking or removing marks from all the images.



4 Press the **MENU** button.

- The selection mode will turn off and the Transfer Order menu will reappear.



- Images are transferred in order from oldest to newest by the shooting date.
- A maximum of 998 images can be marked per CF card.
- Transfer settings can also be assigned to images with the supplied software programs on a computer.

Resetting the Transfer Settings

The transfer marks can all be removed at once.

1 Display the Transfer Order menu (p. 130).

2 Select [Reset] using ◀ or ▶ on the multicontroller and press **SET**.



3 Select [OK] using ◀ or ▶ on the multicontroller and press **SET**.















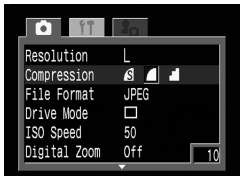

List of Menu Options

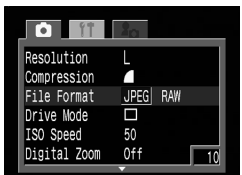
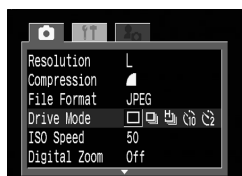
The chart below lists menu items and settings. See Selecting Menus and Settings (p. 38) to learn how to select a setting.

Rec. Menu

* Some items may not appear in certain shooting modes (p. 90).





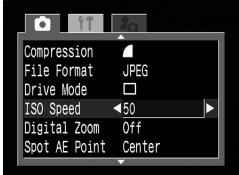
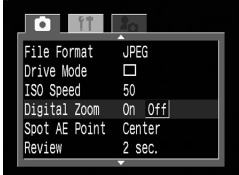
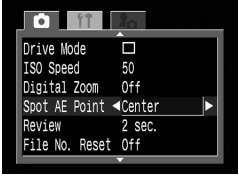
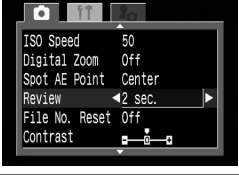
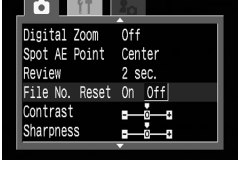

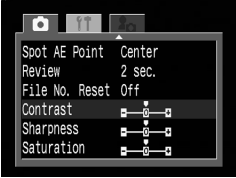
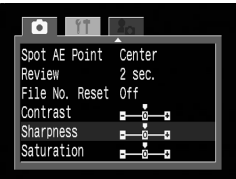
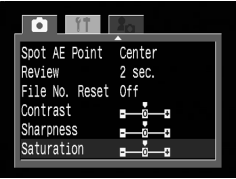

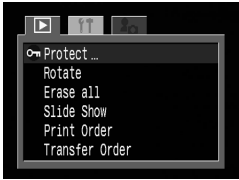

Item	Menu Screen	Settings Content	Reference Page
Resolution (Excluding )		Sets the number of pixels used to record images to CF cards. <ul style="list-style-type: none"> • L Large PowerShot S30 (2048 x 1536 pixels) PowerShot S40 (2272 x 1704 pixels) • M1 Medium 1 (1600 x 1200 pixels) • M2 Medium 2 (1024 x 768 pixels) • S Small (640 x 480 pixels) 	p. 61
Resolution ()		Sets the resolution of the frames as they are recorded to the CF card. <ul style="list-style-type: none"> • 320 (320 x 240 pixels) • 160 (160 x 120 pixels) 	p. 61
Compression		Sets the relative compression ratio used to record images to CF cards. <ul style="list-style-type: none"> •  Superfine •  Fine •  Normal 	p. 61
File Format		Sets the file format used to record images to CF cards. <ul style="list-style-type: none"> • JPEG • RAW 	p. 64
Drive Mode		Sets the single shooting, continuous shooting and its option, or self-timer shooting and its duration. There is no combination of the self-timer shooting and continuous shooting (only single shooting). <ul style="list-style-type: none"> •  Single Shooting •  Standard Continuous Shooting •  High-speed Continuous Shooting •  10 sec Self-Timer •  2 sec Self-Timer 	p. 59

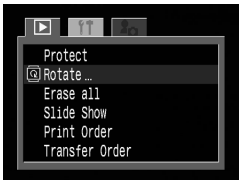
Rec. Menu (continued)



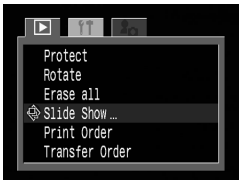





Item	Menu Screen	Settings Content	Reference Page
ISO Speed		Sets the sensitivity at which images are recorded. (S30) (S40) <ul style="list-style-type: none"> • 50 • 100 • 200 • 400 • 800 • AUTO 	p. 87
Digital Zoom		Combines with the optical zoom to zoom images. <ul style="list-style-type: none"> • Off • On 	p. 60
Spot AE Point		Sets the Spot AE Point option, Center (the AE point is fixed to the center) or AF Point (the AE point corresponds to the AF point). <ul style="list-style-type: none"> • Center • AF Point 	p. 82
Review		Sets the duration images display on the LCD monitor after the shutter button is released. <ul style="list-style-type: none"> • Off • 2 sec. • 10 sec. 	p. 46
File No. Reset		Sets how file numbers are assigned to images when new CF cards are inserted. <ul style="list-style-type: none"> • On • Off 	p. 89

Item	Menu Screen	Settings Content	Reference Page
Contrast		Adjusts the image contrast. <ul style="list-style-type: none"> • - • 0 • + 	p. 87
Sharpness		Adjusts the image sharpness. <ul style="list-style-type: none"> • - • 0 • + 	p. 87
Saturation		Adjusts the image saturation. <ul style="list-style-type: none"> • - • 0 • + 	p. 87





Play Menu

Item	Menu Screen	Settings Content	Reference Page
 Protect		Protects images from accidental erasure.	p. 103
 Rotate		Rotates images 90 or 270 degrees clockwise in the display.	p. 97
 Erase all		Erases all images from a CF card (excluding protected images).	p. 105
 Slide Show		Plays images in an automated slide show.	p. 99
 Print Order		Sets the images that will be printed on a DPOF-compatible printer or at a photo lab service, the number of copies and other parameters.	p. 107
 Transfer Order		Sets the images that will be transferred with your e-mail software.	p. 130

Set up Menu











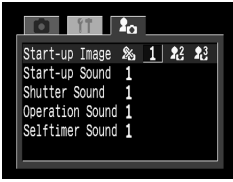

Item	Menu Screen	Settings Content	Reference Page
Beep		<p>Sets whether or not the beep sounds when the shutter button is pressed or when a menu operation is performed.</p> <ul style="list-style-type: none"> • On • Off (Still beeps to warn of an error even when set to Off) <p>See also “How the [Beep] setting in the [ (Set up)] menu and each sound setting in the [ (My Camera)] menu are related” on page 140.</p>	p. 34
LCD Brightness		<p>Sets the brightness level of the LCD monitor.</p> <ul style="list-style-type: none"> •  (Normal) •  (Bright) 	p. 30
Speaker Vol. (Shooting)		<p>Adjusts the sound volume when the shutter button is pressed all the way. The beep does not sound while a movie is being shot.</p> <ul style="list-style-type: none"> • □□□□ (Off) • ■□□□ (1) • ■■□□ (2) • ■■■□□ (3) • ■■■■□□ (4) • ■■■■■ (5) 	p. 34
Playback Vol. (Replay)		<p>Adjusts the sound volume when a movie is played.</p> <ul style="list-style-type: none"> • □□□□ (Off) • ■□□□ (1) • ■■□□ (2) • ■■■□□ (3) • ■■■■□□ (4) • ■■■■■ (5) 	p. 28, 96, 98

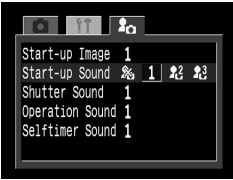
Set up Menu (continued)







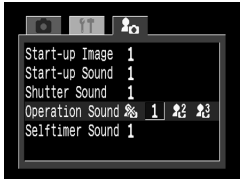

Item	Menu Screen	Settings Content	Reference Page
Auto Power Down		<p>Sets whether or not the camera automatically powers down after a specified period of time elapses without something being pressed.</p> <ul style="list-style-type: none"> • On • Off 	p. 28
Date/Time		Sets the date, time and date format.	p. 24
Format		Formats (initializes) a CF card.	p. 106
Language		<p>Sets the language used in the menus and messages on the LCD monitor. The menu may appear differently in some regions.</p> <ul style="list-style-type: none"> • English • Italiano • Deutsch • Norsk • Français • Svenska • Nederlands • Español • Dansk • Chinese • Suomi • Japanese <p>You can change the language during image replay by holding the SET button and pressing the JUMP button.</p>	p. 25
Video System		<p>Sets the video output signal standard.</p> <ul style="list-style-type: none"> • NTSC • PAL 	p. 142

My Camera Menu

You can select the start-up image and start-up, shutter, operation, and self-timer sounds. You can customize [F2] and [F3] of each item using the supplied software. For details, please refer to the Software Starter Guide.

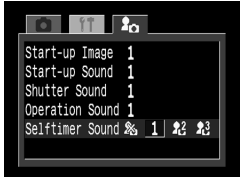
Item	Menu Screen	Settings Content	Reference Page
Start-up Image		<p>Sets the start-up image when you turn on the camera.</p> <ul style="list-style-type: none"> •  • 1 •  •  	p. 40
Start-up Sound		<p>Sets the start-up sound when you turn on the camera.</p> <p>See also “How the [Beep] setting in the [F1] (Set up)] menu and each sound setting in the [F2] (My Camera)] menu are related” on page 140.</p> <ul style="list-style-type: none"> •  • 1 •  •  	p. 40
Shutter Sound		<p>Sets the shutter sound when you depress the shutter button. There is no shutter sound while a movie is being shot.</p> <p>See also “How the [Beep] setting in the [F1] (Set up)] menu and each sound setting in the [F2] (My Camera)] menu are related” on page 140.</p> <ul style="list-style-type: none"> •  • 1 •  •  	p. 40







My Camera Menu (continued)

Item	Menu Screen	Settings Content	Reference Page
Operation Sound		Sets the sound when the multicontroller or any button other than the shutter button is operated. See also “How the [Beep] setting in the [11] (Set up) menu and each sound setting in the [2.6] (My Camera) menu are related” on this page. <ul style="list-style-type: none"> •  • 1 •  •  	p. 40
Selftimer Sound		Sets the sound informing you that the photo will be taken in 2 seconds. See also “How the [Beep] setting in the [11] (Set up) menu and each sound setting in the [2.6] (My Camera) menu are related” on this page. <ul style="list-style-type: none"> •  • 1 •  •  	p. 40

How the [Beep] setting in the [11] (Set up) menu and each sound setting in the [2.6] (My Camera) menu are related

- To actually turn off the sound of the start-up sound, shutter sound, operation sound, and self-timer sound individually, [Beep] in the [11] (Set up) menu must be set to [Off]. If [Beep] is set to [On], the beep sounds even if each sound item in the [2.6] (My Camera) menu is set to [Off].

For details, see the table below.

		The settings of [Beep] in the [11] (Set up) menu	
		[On]	[Off]
The settings of each sound item in the [2.6] (My Camera) menu ([Start-up Sound]/[Shutter Sound]/[Operation Sound]/[Selftimer Sound])		● [Beep]	–
	[1]	● [1]	● [1]
		● 	● 
		● 	● 

● : The sound specified in [] sounds.

– : No sound

Resetting all of the Settings to Default

You can reset all of the menu and button operation settings to default except for [Date/Time], [Language], and [Video System].

1 Turn on the camera.

- You can turn on the camera into either Shooting or Replaying mode.

2 Press the **MENU** button for longer than 5 seconds.

- The message "Reset settings to default?" appears on the LCD monitor.

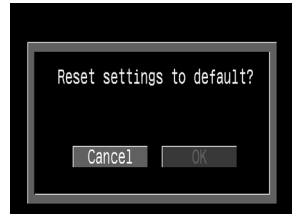

3 Select [OK] using ◀ or ▶ on the multicontroller, then press **SET**.

- The screen on the right hand appears while resetting. The normal screen resumes when resetting is complete.
- To cancel resetting, select [Cancel] instead of [OK].

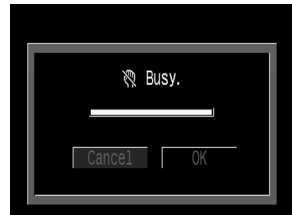

Shooting / Replaying with a TV Monitor

A video-compatible television connected via the supplied AV cable AVC-DC100 can be used to view images as you shoot or replay them.

1 Turn off the camera (p. 27, 29).

2

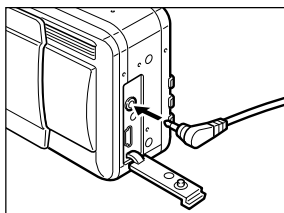

Attach AV Cable AVC-DC100 to the **A/V OUT** terminal on the camera.

3

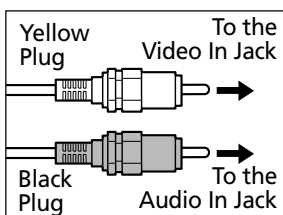

Plug the other ends of the AV cable to the video in and audio in jacks on the TV.

4 Turn on the TV and switch it to Video mode.

5 Turn on the camera in Shooting mode or Replaying mode (p. 27).

- The image will appear on the TV. Shoot or replay images as usual.
- If the images are not appearing on the TV when shooting, press the **DISPLAY** button.



- No image will appear on the LCD monitor when the camera is connected to a TV monitor.
- The video output signal can be switched (NTSC or PAL) to accommodate different regional standards (p. 138). The default setting will vary between regions.
NTSC: Japan, U.S.A., Canada, Taiwan, etc.
PAL: Europe, Asia (excluding Taiwan), Oceania, etc.
If an incorrect video system is set, the output image will not display properly.
- You can plug the AV cable into either the left or right input jack on the TV. Please consult the TV's manual for details.
- A TV monitor cannot be used in  mode.

Camera Care and Maintenance

Use the following procedures to clean the camera body, lens, viewfinder, LCD monitor and other parts.

Camera body	Wipe the body clean with a soft cloth or eyeglass lens wiper.
Lens	First use a lens blower brush to remove dust and dirt, then remove any remaining dirt by wiping the lens lightly with a soft cloth. <ul style="list-style-type: none">• Never use synthetic cleansers on the camera body or lens. If dirt remains, contact the nearest Canon Customer Support Help Desk (see the back of this guide).
Viewfinder	Use a lens blower brush to remove dust and dirt. If necessary, gently wipe the viewfinder and LCD monitor with a soft cloth or an eyeglass lens wiper to remove stubborn dirt.
LCD monitor	Use a lens blower brush to remove dust and dirt. If necessary, gently wipe the viewfinder and LCD monitor with a soft cloth or an eyeglass lens wiper to remove stubborn dirt. <ul style="list-style-type: none">• Never rub or press forcefully on the LCD monitor. These actions may damage it or lead to other problems.



- Never use thinners, benzene, synthetic cleansers or water to clean the camera. These substances may distort or damage the equipment.

Troubleshooting

Problem	Cause	Solution
Camera will not operate	Power is not turned on	<ul style="list-style-type: none"> • Turn on the camera. ➔ See Turning the Power On / Off (p. 27).
	CF card slot/battery cover opened	<ul style="list-style-type: none"> • Confirm that the CF card slot/battery cover is securely closed.
	Insufficient battery voltage	<ul style="list-style-type: none"> • Fully charge the battery or use a household power source.
	Poor contact between camera and battery terminals	<ul style="list-style-type: none"> • Wipe the terminals with a clean, dry cloth.
Camera will not record	Camera is in replaying or computer/printer mode	<ul style="list-style-type: none"> • Switch the camera to Shooting mode. ➔ See Switching between Shooting and Replaying (p. 29).
	Flash is charging (flashing orange indicator)	<ul style="list-style-type: none"> • Wait until the orange indicator stops flashing and shines steadily, signaling that the flash is charged, then press the shutter button.
	CF card full	<ul style="list-style-type: none"> • Insert a new CF card. • If required, download the images to a computer and erase them from the CF card to make space.
	CF card not formatted correctly	<ul style="list-style-type: none"> • Format CF card. ➔ See Formatting a CF card (p. 106). • If reformatting doesn't work, the CF card logic circuits may be damaged. Contact the nearest Canon Customer Support Help Desk.
Lens will not retract	CF card slot/battery cover opened with camera on	<ul style="list-style-type: none"> • Close the CF card slot/battery cover, then turn off the camera.
	CF card slot/battery cover opened while camera was recording to CF card (warning signal)	<ul style="list-style-type: none"> • Close the CF card slot/battery cover, then close the lens cover.
	Switched to replaying mode from shooting mode	<ul style="list-style-type: none"> • The lens does not retract in this case. To let the lens retract, close the lens cover.

Problem	Cause	Solution
Battery pack consumed quickly	Battery pack capacity reduced because of disuse for one year or more after being fully charged	<ul style="list-style-type: none"> • Replace the battery pack with a new one.
	Battery life exceeded	<ul style="list-style-type: none"> • Replace the battery pack with a new one.
Battery pack will not charge	Battery life exceeded	<ul style="list-style-type: none"> • Replace the battery pack with a new one.
	Poor contact between battery charger and battery	<ul style="list-style-type: none"> • Clean the battery terminals with a clean dry cloth. • Insert the charger plug firmly into the electrical outlet.
Image is blurred or out of focus	Camera moved	<ul style="list-style-type: none"> • Be careful not to move the camera when pressing the shutter button. • Use a tripod at slow shutter speeds when the camera shake warning  appears.
	Autofocus function hampered by obstruction to AF auxiliary light emitter	<ul style="list-style-type: none"> • Be careful not to block the AF auxiliary light emitter with your finger or other items.
	Subject out of focal range	<ul style="list-style-type: none"> • Ensure that there is at least 80 cm (2.7 ft.) between the camera lens and subject. • Use the macro mode to shoot close-ups between 10 and 80 cm (3.9 in. and 2.7 ft.) at maximum wide angle and 30 and 80 cm (12 in. and 2.7 ft.) at maximum telephoto.
Subject in recorded image is too dark	Insufficient light for shooting	<ul style="list-style-type: none"> • Set the flash to on.
	Subject dark in comparison to the background	<ul style="list-style-type: none"> • Set the exposure compensation to a positive (+) setting. • Use the AE lock or spot metering function. <ul style="list-style-type: none"> ➔ See Locking the Exposure Setting (AE Lock) (p. 79) and Switching between Metering Modes (p. 82)
	Subject too far for flash to reach	<ul style="list-style-type: none"> • To use the built-in flash, shoot within the following ranges: When sensitivity is set to AUTO: 35 cm - 4.8 m (1.15 ft. - 15.75 ft.) (W) 35 cm - 3.0 m (1.15 ft. - 9.84 ft.) (T) When sensitivity is set to ISO 100 equivalent: 55 cm - 4.0 m (1.8 ft. - 13.1 ft.) (W) 55 cm - 2.5 m (1.8 ft. - 8.2 ft.) (T) • Raise the ISO sensitivity and then shoot. See Manually Setting Image Characteristics (p. 87)

Troubleshooting (continued)

Problem	Cause	Solution
Subject in recorded image is too bright	Subject too close	<ul style="list-style-type: none"> • Adjust the flash output with the flash exposure compensation function (p. 78).
	Subject bright in comparison to the background	<ul style="list-style-type: none"> • Set the exposure compensation to a negative (-) setting. • Use the AE lock or spot metering function. <ul style="list-style-type: none"> ➔ See Locking the Exposure Setting (AE Lock) (p. 79) and Switching between Metering Modes (p. 82)
	Light shining directly on subject or reflected off subject into camera	<ul style="list-style-type: none"> • Change the shooting angle.
	Flash set to On	<ul style="list-style-type: none"> • Set the flash to Auto or Off.
Flash will not fire	Flash set to Off	<ul style="list-style-type: none"> • Set the flash to Auto or On.
Image not showing on TV	Camera is set to off	<ul style="list-style-type: none"> • Turn the camera on to either shoot or replay.
	Incorrect video system setting	<ul style="list-style-type: none"> • Set the video system to the appropriate setting, NTSC or PAL, for your TV ➔ (See Set up Menu, p. 138).
Zoom does not operate	Zoom lever was moved while shooting in movie mode.	<ul style="list-style-type: none"> • Operate the zoom before shooting in movie mode.

List of Messages

The following messages may appear on the LCD monitor.

Reset settings to default?	Do you wish to reset all the camera and menu settings to default?
Resetting	Resetting all the camera and menu settings to default
Busy...	Image is being recorded to, or read from, CF card.
No CF card:	You attempted to shoot or replay images without a CF card installed.
Cannot record!:	You attempted to shoot an image without a CF card installed.
CF card error!:	CF card has experienced an anomaly.
CF card full:	CF card is too full to save more images or print settings.
Naming error!:	The file could not be created because there is a file with the same name as the directory that the camera is attempting to create, or the highest possible file number has already been reached. In the Rec. menu, please set [File No.] Reset to [On]. After you save all the images you wish to retain onto a computer, format the CF card (p. 102). Please note that formatting will erase all the existing images and other data.
Change the battery pack:	Battery charge is insufficient to operate the camera. Replace it immediately with a charged battery pack or recharge it.
No image:	No images recorded on CF card.
Image too large:	You attempted to replay an image larger than 3200 x 2400 pixels.
Incompatible JPEG format:	You attempted to replay an incompatible JPEG file.
Corrupted data:	You attempted to replay an image with corrupted data.
RAW:	You attempted to replay an image recorded in an incompatible RAW format.

List of Messages (continued)

Cannot magnify!:	You attempted to magnify an image that was photographed with another camera, recorded in a different format, or edited on a computer.
Cannot rotate:	You attempted to rotate an image that was photographed with another camera, recorded in a different format, or edited on a computer.
Unidentified Image	You attempted to replay an image that was recorded in a special format (proprietary format used by the camera of another manufacturer, etc.).
Unidentified Sound Data	Cannot attach sound annotation to the image because the image has some sound file recorded in an inappropriate format.
Protected!:	You attempted to erase a protected image.
Too many marks:	Too many images have been marked for printing or for inclusion in a slide show. Cannot process any more.
Cannot mark image:	You attempted to set the print settings for a non-JPEG file.
Cannot complete!:	Couldn't save the print or slide show settings.
Cannot edit:	Slide show settings file is corrupted

The following messages may appear on the camera's LCD monitor when Card Photo Printer CP-10 is printing.

No Paper:	Paper cassette is incorrectly inserted or out of paper. Or the paper feed isn't operating correctly.
No Ink:	The ink cartridge has not been inserted or has run out of ink.
Ink Cassette Error:	The ink cassette is experiencing a problem.
Paper Jam:	The paper jammed during printing.
Communication Error:	The printer is experiencing a data transmission error.
Cannot trim:	You attempted to trim an image from another camera, one recorded in a different format, or one that has been edited on a computer.
Readjust trimming:	You attempted to print the image with a different style than the one used when the trimming settings were set.
Cannot Print!:	You attempted to print an image from another camera, one recorded in a different format, or one that has been edited on a computer.
Could not print xx images:	You attempted to use the DPOF print settings to print xx images that are from another camera, that have been recorded in a different format, or that have been edited on a computer.

List of Messages (continued)

The following messages may appear when the camera is connected to Bubble Jet Printer with the direct print function.

The error number is displayed on the control panel of Bubble Jet Printer. Please refer to the Bubble Jet Printer Quick Start Guide for the remedies corresponding to the error numbers.

Printer in use:	The printer is printing the data from the memory card inserted in the computer or printer. The printer automatically starts printing the images from the camera after completing the current printing.
Printer warming up:	Printer is warming up. When it is ready, the printer starts printing automatically.
No printhead	No print head is installed in the printer.
Printer cover open	Close the printer cover securely.
Media type error	Cancel printing. Set the paper you chose in the Print Style.
Paper lever error	Adjust the paper selection lever to the proper position.
Low ink level	The ink tank needs to be replaced soon. Prepare a new ink tank. If you select [Continue] in the error screen, you can restart printing.
Waste tank full	You can restart printing by pressing the RESUME/ CANCEL button on Bubble Jet Printer. Please request replacement of the waste tank to the shop where you purchased the printer or your nearest Canon customer support center listed in the Bubble Jet Quick Start Guide.
Printer error	Turn off the printer, then turn it on again. If the error persists, please consult your nearest Canon customer support center listed in the Bubble Jet Quick Start Guide.

Specifications

All data is based on Canon's standard testing methods. Subject to change without notice.

PowerShot S30 / PowerShot S40	
Camera effective pixels:	S30 Approx. 3.2 million S40 Approx. 4 million
Image sensor:	S30 1/1.8 inch CCD (Total number of pixels: approx. 3.3 million) S40 1/1.8 inch CCD (Total number of pixels: approx. 4.1 million)
Lens:	7.1 (W)-21.3 (T) mm (35mm film equivalent 35-105 mm) F2.8(W) -4.9 (T)
Digital tele-converter:	S30 Max. approx. 3.2 × (Maximum 10x digital zoom is available when combined with optical zoom) S40 Max. approx. 3.6 × (Maximum 11x digital zoom is available when combined with optical zoom)
Optical viewfinder:	Real-image optical zoom viewfinder, picture coverage = approx. 82%
LCD viewfinder:	1.8-inch, low-temperature polycrystalline silicon TFT color LCD, picture coverage = 100%
Autofocus method:	TTL 3 point AiAF (1 point measurement is possible) Focus lock and Manual focus are available
Focusing range (from tip of the lens barrel):	Normal AF: 80 cm (2.7ft.) – ∞ Macro AF: 10 cm (W) / 30 cm (T) – 80 cm (3.9 in. (W) / 11.8 in. (T) – 2.6 ft.) Manual focus: 10 cm (W) / 30 cm (T) – ∞ (3.9 in. (W) / 11.8 in. (T) – ∞)
Shutter:	Mechanical shutter + electronic shutter
Shutter speeds:	15 – 1/1500 sec. 1.3 sec. or more shutter is available in Shutter-Priority mode or Manual mode Slow shutter speeds of 1.3 sec. or more operates with noise reduction
Light metering method:	Evaluative metering, Center-weighted average metering, Spot metering (Center or AF Point)
Exposure control method:	Program AE, Shutter-priority AE, Aperture-priority AE or Manual exposure control AE lock is available
Exposure compensation:	±2.0 EV (in 1/3-stop increments) Auto exposure bracketing (AEB) is available
Sensitivity (equivalent film speed):	Auto, ISO 50, ISO 100, ISO 200, ISO 400 and ISO 800* equivalent (In Auto mode, camera automatically adjusts sensitivity in the range of 1 ISO 50 to ISO 100 equivalent) *Only for PowerShot S30
White balance:	TTL auto white balance, pre-set white balance (available settings: Daylight, Cloudy, Tungsten, Fluorescent, Fluorescent H or Flash) or Custom white balance
Flash:	Red-eye reduction auto, Auto, Red-eye reduction On, On or Off

Specifications (continued)

Flash range:	(When sensitivity is set to AUTO) 35 cm - 4.8 m (1.15 ft. - 15.75 ft.) (W), 35 cm - 3.0 m (1.15 ft. - 9.84 ft.) (T) (When sensitivity is set to ISO 100 equivalent) 55 cm - 4.0 m (1.8 ft. - 13.1 ft.) (W), 55 cm - 2.5 m (1.8 ft. - 8.2 ft.) (T)
Flash exposure compensation:	±2.0EV (in 1/3-stop increments), FE lock is available
Shooting modes:	Auto Creative zone: Program, Shutter Speed Priority, Aperture Priority and Manual Image zone: Portrait, Landscape, Night Scene, Fast Shutter, Slow Shutter, Color Effect, Stitch Assist and Movie
Continuous shooting:	High-Speed continuous shooting: Approx. 3 image/sec. (S30), Approx. 2.5 image/sec. (S40) Standard continuous shooting: Approx. 2 image/sec. (S30), Approx. 1.5 image/sec. (S40) (Large/Fine mode with LCD viewfinder off)
Self-timer:	Approx. 2 sec./10 sec. shutter release delay
PC-connected shooting:	Available (USB connection only. Use the supplied software RemoteCapture.)
Storage media:	CompactFlash™ (CF) card (Type I and Type II)
File Format:	Design rule for Camera File system, DPOF-compliant
Image recording format	Still images: JPEG or RAW Movies: AVI (Image data: Motion JPEG, Audio data: WAVE [monaural])
JPEG compression mode:	Super fine, Fine or Normal
Number of recording pixels:	Still images: Large: (S30) 2048 x 1536 pixels (S40) 2272 x 1704 pixels Medium 1: 1600 x 1200 pixels Medium 2: 1024 x 768 pixels Small: 640 x 480 pixels Movies: 320 x 240 pixels (Approx. 30 sec.)** 160 x 120 pixels (Approx. 120 sec.)** Approx. 15 frames/sec. ** The data in parentheses refer to the maximum movie length per shooting
Playback modes:	Single (Histogram displayable), Index (9 thumbnail images), Magnified (S30: approx. 2.5x or 5x, S40: approx. 3x or 6x on build-in LCD monitor) or Slide show Sound annotations (up to 60 sec.) Image output to Card Photo Printer CP-10 and Bubble Jet Printer with the direct print function
Display languages	English, Deutsch, Français, Nederlands, Dansk, Suomi, Italiano, Norsk, Svenska, Español, Chinese and Japanese

My Camera Settings (customizing):	Start-up Image, Start-up Sound, Shutter Sound, Operation Sound and Selftimer Sound Customizing is possible by downloading data from your computer using the supplied software.
Interface:	Universal Serial Bus (USB), Audio/Video Output (NTSC or PAL selectable, monaural audio)
Power source:	1. Rechargeable Lithium-ion battery (type: NB-2L) (supplied) 2. AC Adapter kit ACK 700 (optional)
Operating Temperatures:	0 – 40°C
Operating Humidity:	10 – 90%
Dimensions (W × H × D):	112 × 58 × 42 mm (4.4 × 2.3 × 1.7 in.) (excluding protrusions)
Weight:	Approx. 260g (9.2 oz.) (camera body only)

(W): wide angle (T): telephoto

Battery Pack NB-2L

Type:	Rechargeable lithium ion cell
Nominal voltage:	7.4 V
Nominal amperage:	570 mAh
Charge cycles:	Approx. 300
Operating temperatures:	0 - 40° C (32 - 104° F)
Dimensions:	33.3 × 45.2 × 16.2 mm (1.3 × 1.8 × 0.6 in.)
Weight:	Approx. 40 g (1.4 oz.)

Battery Charger CB-2LT / CB-2LTE

Input voltage:	AC 100 - 240 V (50/60 Hz) 0.17 A (100V) - 0.10 A (240V)
Rated output:	8.4 V DC, 0.5 A
Operating temperatures:	0 - 40° C (32 - 104° F)
Dimensions:	91 × 29.5 × 56 mm (3.6 × 1.2 × 2.2 in.)
Weight:	CB-2LT: Approx. 86 g (3.0 oz.)/CB-2LTE: Approx. 82 g (2.9 oz)

Compact Power Adapter CA-PS700 (optional)

Input voltage:	AC 100 - 240 V (50/60 Hz) 0.32 A
Rated output:	7.4 V DC / 2.0 A
Operating temperatures:	0 - 40°C (32 - 104°F)
Dimensions:	112 × 29 × 45 mm (4.4 × 1.1 × 1.8 in.)
Weight:	Approx. 186 g (6.6 oz.)

CompactFlash™ Card

Card slot type:	Type I
Dimensions:	36.4 x 42.8 x 3.3 mm (1.4 x 1.7 x 0.1 in.)
Weight:	Approx. 10 g (0.4 oz.)

Index

A

- AC Adapter Kit 19
- AEB Mode 77
- AE Lock 79
- AF Frame
 - Auto Selection 71
 - Manual Selection 71
- Aperture-Priority AE (**Av**) 68
- Aperture Settings 65, 66, 68, 70
- Auto Mode (**AUTO**) 44
- Auto Exposure Bracketing (AEB Mode) 77
- Auto Replay (Slide Show) 99, 136
- A/V Out Terminal 10, 142

B

- Battery Pack
 - Charging 15
 - Handling Precautions 16
 - Installing 17
 - Low Status 18
 - Performance 18
- Battery charger 15
- Beep 137, 139, 140
- Black and White Mode 52
- Brightness
 - LCD Monitor 137

C

- Camera Care and Maintenance 143
- CF Card
 - Formatting 106
 - Handling 23
 - Installing 21
 - Recording Capacity 22
- Cleaning 143
- Color Effect 52
- CompactFlash™ Card 21, 22, 23, 106
- Compact Power Adapter 19
- Components Guide 10
- Compression 61, 133
- Continuous Mode (**C**) 59
- Contrast 87, 135
- Creative Zone 13

D

- Date/Time 24, 138
- DC Coupler 19
- Digital Print Order Format (DPOF) Settings
 - Print Settings 107, 119, 128
 - Transfer Order 130
- Digital Terminal 10, 112, 121
- Digital Zoom 37, 60, 134
- Display Modes 30 - 33
 - Detailed 30, 32
 - Simple 30, 32

DPOF

- Print Settings 107, 119, 128
- Transfer Order 130

E

- Erasing
 - All Images 105
 - Displayed Images 9
 - Single Images 104
- Exposure
 - AEB 77
 - AE Lock 79
 - Aperture-Priority AE (**Av**) 68
 - Compensation 73
 - Flash Exposure Compensation 78
 - Shutter Speed-Priority AE (**Tv**) 66
 - White Balance 74
- Exposure Compensation 73

F

- Fast Shutter 50
- FE Lock 81
- File Format 64, 133
- File No. Reset 89
- File Numbers 89
- Flash 47
- Flash Exposure Compensation 78
- Focal Length 37
- Focus
 - Lock 84
 - Manual 86
- Format 106

H

- Histogram 33
- Household Power Source 19

I

- Image Characteristics 87
 - Contrast 87
 - ISO Speed 87
 - Saturation 87
 - Sharpness 87
- Image Zone 13
- Index Replay 94
- Indicators 12, 27
- Information View 31 - 33
- Interface
 - Cables 10, 112, 121
- ISO Speed 87

J

- Jump 95

L

- Landscape Mode (🏞️) 49
- Language Settings 25, 138
- LCD Monitor 30 - 33
 - Brightness 137
- Light Metering
 - Center-Weighted Averaging 82
 - Evaluative 82
 - Spot AE Point (AF Point) 82
 - Spot AE Point (Center) 82

M

- Macro Mode (🔍) 57
- Magnifying Images 93
- Manual
 - Exposure (M) 70
 - Focus (MF) 86
 - Setting Image Characteristics 87
 - Shooting Mode 70
- Menu
 - List of Options 133
 - Play 136
 - Rec 133
 - Selecting Menus and Settings 38
 - Set up 39, 40
- Messages 147
- Movie (🎬)
 - Shooting 56
 - Replaying 96
- My Camera
 - Menu 41, 139
 - Settings 41

N

- Night Scene Mode (🌃) 50

O

- Overexposure Warning 33
- Operation Sound 40 - 43, 140

P

- PC Connection Mode 12, 28
- Play 92
- Portrait Mode (👤) 49
- Program AE (P) 65
- Protect 103, 136
- Print Settings 107
 - Selecting Images 107
 - Print Style 109
 - Resetting 111
- Power On/Off 27 - 29
- Power Save 28, 138

R

- RAW File Format 64, 133
- Recording File Format 64
- Red-Eye Reduction Function 48
- Replay
 - Index Replay 94
 - Jumping 95
 - LCD Monitor 92
 - Magnifying Images 93
 - Movies 96
 - Rotating 97
 - Single Image Replay 92
 - Slide Show 99
 - Switching from Shooting Mode 29
 - TV 142
 - Volume 137
- Resolution 61
- Resetting the settings to default 141
- Rotate 97

S

- Saturation 87
- Self-Timer 58
 - Sound 41 - 43, 140
- Sharpness 87
- Shooting 27, 29, 44
 - Checking Images 46
 - Switching from Replaying Mode 29
 - TV Monitor 142
- Shooting Mode 90
 - Dial 13
 - Functions Available 90
- Shutter
 - Sound 41 - 43, 139
 - Shutter Speed Priority AE (Tv) 66
 - Speed 65, 66, 68, 70
 - Volume 137
- Shutter Button 34
 - Pressing Halfway 34
 - Pressing Fully 34
- Single Image Replay 92
- Slide Show 99, 136
 - Play Time 101
 - Repeat 101
 - Selecting Images 100
 - Starting 99
- Slow Shutter 51
- Soft Case 26
- Sound Annotations 98
- Speaker 10
- Specifications 151 - 154
- Spot Light Metering 82

Start-up
Image 28, 41 - 43, 139
Sound 28, 41 - 43, 139
Stitch Assist Mode (□) 53
Framing Subjects 53
Shooting 54
Strap 26

T

Telephoto 37
Transfer Order
Reset 132
Selecting Images 130
Troubleshooting 144 - 146

V

Video System 138, 142
Viewfinder
LCD Monitor 12, 30
Optical 10, 36
Volume
Replay 137
Shooting 137

W

WAV Files 32, 43, 98
White Balance 74
Wide Angle 37

Z

Zoom 37, 60, 93

Canon Customer Support

Canon Inc.

30-2 Shimomaruko 3-chome, Ohta-ku, Tokyo
146-8501, Japan

NORTH AMERICA

Canon U.S.A., Inc.

Canon Customer Care Center
Phone (US): 1-800-828-4040 (Available Mon. - Fri., 9 AM to 8 PM Eastern Time)

Canon Canada Inc.

Phone (Canada): 1-800-OK-CANON (1-800-652-2666) (24 hours/day, 7 days/week)

EUROPE

Europe, Africa & Middle East

Canon Europa N.V.

PO Box 2262, 1180 EG Amstelveen, The Netherlands

Canon (UK) Ltd.

Helpdesk
Tel.: 08705 143 723 (Calls may be recorded.) Fax.: 08705 143 340

Canon Communication & Image France S.A.

Tél : 01.41.30.15.15 Télécopie : 01.41.30.15.05

Canon Deutschland GmbH

Canon-Hotline-Service:
Customer Support: (02151) 349-555
Info Desk: (02151) 349-566 Fax: (02151) 349-588

Canon Euro-Photo GmbH

Customer-Support: (02154) 495-610 Fax: (02154) 495-333

Canon Italia S.p.A.

Pronto Canon: 02 8249 2000

Canon Belgium N.V. / S.A.

Helpdesk: 0900-10627
Tel.: (02) 722.04.11 Fax: (02) 721.32.74

Canon Luxembourg S.A.

Tel.: (352) 48 47 961 Fax: (352) 48 47 96232

Canon Nederland N.V.

Helpdesk: 023 - 5 681 681
Tel.: 023 - 5 670 123 Fax: 023 - 5 670 124

Canon Danmark A/S

Phone: +45 44882400 e-mail: helpdesk@canon.dk

Canon España S.A.

Help Desk: 906 301 255
Fax: (91) 411 76 65 E-mail: helpdesk1@btlink.net

Canon Norge as

Tlf. 22 62 93 21 Faks: 22 62 06 15
E-mail: helpdesk@canon.no

Finland

Canon OY

Puhelin: 010 54420 Fax: 010 544 4571
Help Desk: 0600 0 22606 (14,80 mk/min+pvm)
Help Desk: 0600 0 22666 (enint. 40mk/puhelu+pvm)
Sähköposti: helpdesk@canon.fi

Canon (Schweiz) AG

Tel. 01-835-6161 Fax: 01-835-6526 Hotline 0900 57 55 20

Canon Svenska AB

Tel: 08-744 85 00 Fax: 08-744 64 65

Austria

Canon GmbH

Oberlaaerstraße 233 A-1100 Vienna
Tel: 01 680 88-0 Fax: 01 680 88-308

OCEANIA

Canon Australia Pty. Ltd.

Info-Line: (02) 9805 2864

Canon New Zealand Ltd.

Info-Line: 0900-522666

ASIA

Canon Singapore Pte. Ltd.

79 Anson Road, #09-01 / 06, Singapore 079906
Phone: (65) 532 4400 Fax: (65) 221 7577

Canon Hongkong Co., Ltd.

9/F, The Hong Kong Club Building, 3A Chater Road, Central, Hong Kong
Phone: 852-2739-0802 Fax: 852-2369-7701

Canon Marketing Services

No.1 Jalan Kilang Timor, #09-00, Pacific Tech Centre, Singapore 159303
Phone: (65) 799 8888 Fax: (65) 273 3317

Canon Marketing (Malaysia) Sdn. Bhd.

Wisma General Lumber, Block D, Peremba Square, Saujana Resort, Section U2, 40150, Shah Alam, Selangor Darul Ehsan, Malaysia
Phone: (60) 3 744 6000, (60) 3 745 0055 Fax: (60) 3 745 0505

Canon Marketing (Thailand) Co., Ltd.

10th Floor, Bangkok City Tower, 179/34-45 South Sathorn Road, Bangkok 10120, Thailand
Phone: (662) 344 9999 Fax: (662) 344 9910

Canon Marketing (Hongkong) Co., Ltd.

10/F, Mirror Tower, 61 Mody Road, Tsimshatsui East, Kowloon HongKong
Phone: 852-2170-2828 Fax: 852-2723-9684

FCC Notice

Digital Camera, Model PC1016 and PC1018

This device complies with Part 15 of the FCC Rules. Operation is subject to the following two conditions;

- (1) this device may not cause harmful interference, and
- (2) this device must accept any interference received, including interference that may cause undesired operation.

Note: This equipment has been tested and found to comply with the limits for Class B digital devices, pursuant to Part 15 of the FCC rules. These limits are designed to provide reasonable protection against harmful interference in a residential installation. This equipment generates, uses and can radiate radio frequency energy and, if not installed and used in accordance with the instructions, may cause harmful interference to radio communications. However, there is no guarantee that interference will not occur in a particular installation. If this equipment does cause harmful interference to radio or television reception, which can be determined by turning the equipment off and on, the user is encouraged to try to correct the interference by one or more of the following measures:

- Reorient or relocate the receiving antenna.
- Increase the separation between the equipment and receiver.
- Connect the equipment into an outlet on a circuit different from that to which the receiver is connected.
- Consult the dealer or an experienced radio/TV technician for help.

The cables with the ferrite core provided with the digital camera must be used with this equipment in order to comply with Class B limits in subpart B of Part 15 on FCC rules.

Do not make any changes or modifications to the equipment unless otherwise specified in the manual. If such changes or modifications should be made, you could be required to stop operation of the equipment.

Canon U.S.A. Inc.

One Canon Plaza, Lake Success, NY 11042, U.S.A.

Tel No. (516) 328-5600

Canadian Radio Interference Regulations

THIS CLASS B DIGITAL APPARATUS MEETS ALL REQUIREMENTS OF THE CANADIAN INTERFERENCE CAUSING EQUIPMENT REGULATIONS.

Réglementation canadienne sur les interférences radio

CET APPAREIL NUMERIQUE DE LA CLASSE B RESPECTE TOUTES LES EXIGENCES DU REGLEMENT SUR LE MATERIEL BROUILLEUR DU CANADA.

Canon